

Manual Switches



Selection

Pushbutton panels. Low profile SLP pushbutton panels feature standard matrices and custom arrays tailored to your requirements. They use a conductive rubber technology for operator feedback. Plus full-face LED lighting and legends, and a variety of button sizes and colors.

Manual switches. Designed by industrial designers to achieve a balance between harmonious appearance and ergonomics, AML Advanced Manual Line has pushbuttons, paddles, and rockers; with LED, incandescent, and neon illumination. Plus matching indicators and LED annunciators. A smaller cousin, MML Miniature Manual Line, offers many AML features in a space-saving size.

Pushbuttons. A wide array of different pushbutton families, many with lighted display and matching indicators. Includes Series 2, an easily assembled modular design with many color display/control options; low-cost DM pushbuttons and compact PB unlighted pushbuttons.

Toggles/Rockers. NT/TL, TS, TW and AT toggles, and NR/TP rockers feature various degrees of sealing, choice of many circuitry combinations, and 2 or 3-position operation.

Manual Switches

Advanced Manual Line



IN FRONT OF THE PANEL

Coordinated, attractive appearance. AML features innovations designed by industrial designers to achieve the best balance of human factors and aesthetic appearance. Operator height, bezel size, and the compatibility of square and rectangular shapes blend with other components to harmonize your panel. There's no visual clutter to distract from man/machine communication.

This comprehensive line of lighted and unlighted manual controls features:

- Pushbuttons for high and intermediate frequency functions;
- Rocker and paddle switches, with 2 or 3 positions, for less frequent control functions;
- Plus lighted indicators and annunciators which complement AML's universal appeal.

Various controls can be matched with their functions to accommodate the most natural and efficient habit pattern reflex. Keylock operated switches can be used to assure "authorized personnel only" access.

Display flexibility. AML offers a choice of five legend sizes, four button heights, full or split section display, and illumination by incandescent lamps, LED's or neons. Colors are bright and uniform, providing a strong definition and good visibility. (Non-illuminated devices have the same attractive colors.)

Color display options include:

- Transmitted color — color can be distinguished whether lamp is On or Off.
- Dead front — display appears black, until illumination causes legend and color to appear.
- Projected color — white display is diffused with color when illuminated.

BEHIND THE PANEL

AML's simple, cost effective design provides many behind-panel benefits for the designer and installer/user.

Simple to install. They snap in from the panel front individually or in vertical or horizontal strips; or in subpanel mounted strips and matrices that can be pre-assembled and pre-wired to assure accurate alignment and efficient panel building.

Electrical flexibility. Solid state switches with Hall effect integrated circuits interface directly with microprocessors and other logic level devices. These IC's were first applied in MICRO SWITCH solid state keyboards. Today, many MICRO SWITCH products incorporate the Hall effect technology to meet a wide range of position sensing and manual control needs.

Electronic control switches with gold or silver contacts, and 1, 2, or 4 poles, will handle up to 3 amps. Including an encoded version which generates different binary coded outputs merely by changing cam-keyed buttons.

Power duty switches meet line disconnect application needs with 10-amp push-buttons and 15-amp paddle and rocker switches.

Easy to wire. All AML devices present single level termination. This means faster, easier, neater, and more economical wiring. And there is a choice of solder, quick-connect, push-on, and printed circuit termination.

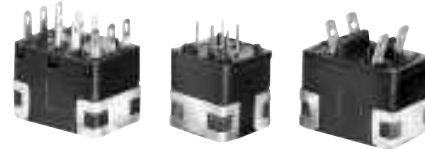

MATING RECEPTACLES

The .110 x .020 quick-connect/solder terminal (types 2 and 8) is designed for use with receptacles that comply with the UL standard for insertion and withdrawal forces. Maximum insertion force is 12 lbs. max., withdrawal force is 14 lbs. These receptacles are supplied by: AMP Inc., Berg, Augat, Hollingsworth, MALCO, Zierick, and others. Refer to Thomas Register or the Yellow Pages for the location of your local supplier.

Applying Manual Controls and Displays

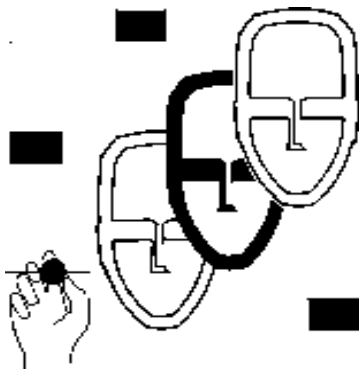

Adherence to good human factors principles can help your product make good first impressions as it is being evaluated by your customers; and increase long-term user satisfaction. You can gain a competitive edge that may translate into better acceptance by your customer and the user.

The panel, being the surface provided for display and control components, serves as the direct interface for human/machine dialogue. We'd like to offer the following guidelines to help you achieve ergonomically pleasing panels where communication flows operator-to-machine, and back again.

PREPARATION

Begin with procedures common to any design process. Prepare a list of the requirements related to the job to be performed. Then ask yourself such questions as:

- What is the panel (control station) to do?
- Who will be the users?
- Is there a special sequence of procedures to follow?
- Are there special environmental conditions or military requirements?
- Will the equipment be used inside or outside; in a shop, home or office?
- Will barriers, guards or protective shields be needed to safeguard components and/or users?
- Will the maintenance tasks be performed by the equipment user or a technician? How often and how easy to do?
- Who will install or set up the equipment?
- Are elaborate instructions required or can you design to make them unnecessary?
- What components are available?
- Will you do the specifying?
- What are the cost constraints?
- What elements should be added to estimate total installed cost?

Explore as many alternate means of achieving the desired results as possible. Then select the most effective combination of components. The earlier the foregoing questions are asked and answered in the concept or selection process, the more closely the panel design will match the requirements of a given application.

MATCH CONTROL TO FUNCTION

People expect controls to move in certain ways. Where possible, component selection should be an extension of normal habit patterns. For example, the wall-mounted toggle switch found in homes conveys a habit pattern for turning on lights. The upward flipping motion generally associated with "ON" can be used with other toggle, rocker and paddle switches for a natural transfer of a previously learned habit.

The clockwise motion of a rotary knob is frequently used to select an appliance function, such as the desired washer cycle. This same familiar action may be adapted to a control panel as an extension of a normal habit pattern.

When a panel uses control actions well-established in our daily lives:

- Reaction time is reduced.
- The first control movement by an operator is usually correct.
- An operator can perform faster, and can make adjustments with greater precision.
- An operator can learn control procedures faster.

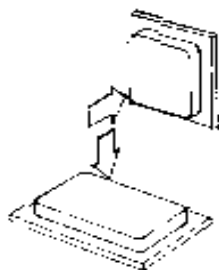

Pushbuttons (alternate-action or momentary)

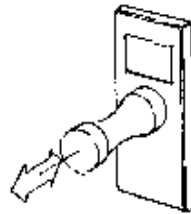

Push/pull switches

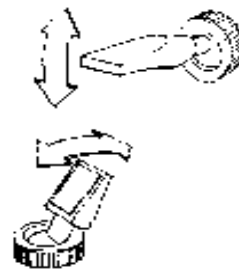

Toggles for 2- or 3-position select

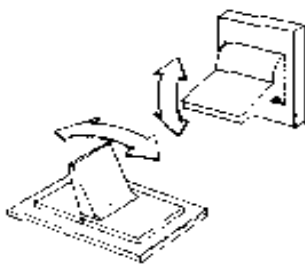

Paddles for 2- or 3-position select

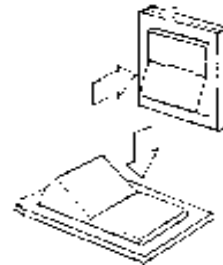

Rockers for 2- or 3-position select

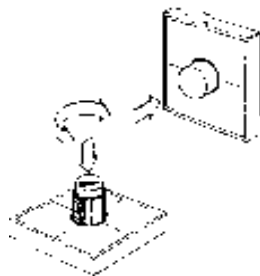

Pushbutton and rotary pushbutton/selector



Trackball and joystick controls for 3-D maneuvering of CRT cursors in mapping or tracking tasks

Applying Manual Controls and Displays

COMPONENT ARRANGEMENT

Some control panels become overly complex because of the number and different types of components, or because the designer failed to explore enough alternative arrangements.

Before drawing the elements on a panel outline, it is helpful to make paper cutouts of the separate switches, indicators, etc. These cutouts can be easily shifted into various groups, and relationships until the most effective arrangement is found. You will save hours of tedious drawing, erasing and redrawing, and should achieve a better layout. Also, you are more likely to resist the temptation to stop looking for the optimal solution too early in the design process.

Here are some suggestions for good arrangement:

1. Frequently used components should be the most accessible.
 - for manually operated controls, somewhere between elbow and shoulder height.
 - for displays, nearest the normal line of sight.
2. Arrange controls and displays for a conventional sequence of operation, left-to-right and top-to-bottom, just as we normally read.
3. Define functional areas by leaving space between component groups. Avoid outline borders, color patches and brackets extending from group titles (except in cases of extreme density.)
4. Locate emergency controls and displays prominently on the panel to assure easy viewing and access by the operator.
5. Where large layouts are necessary, distribute the workload between both hands of the operator — for ease of operation and increased productivity.
6. Locate displays above (preferable) or to the left of corresponding manual controls to prevent visual interference while the manual controls are being operated. (When manual controls are at the extreme left of a panel, displays should be above the controls.)

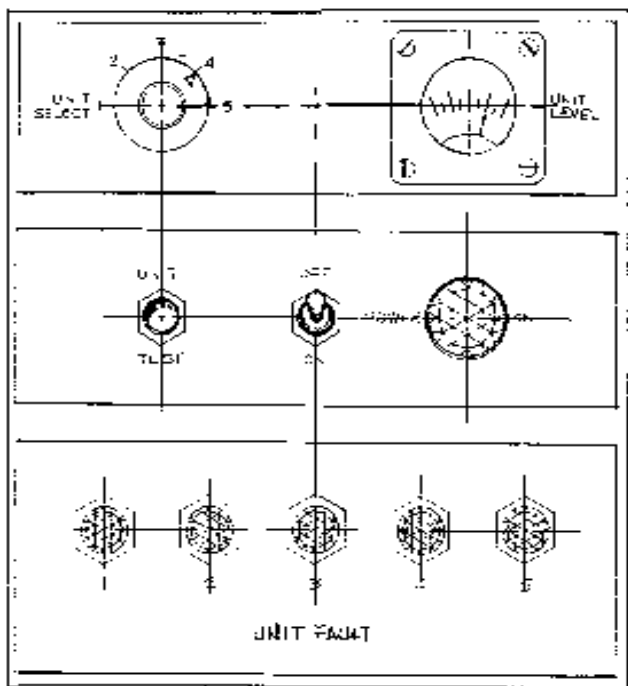

Poor

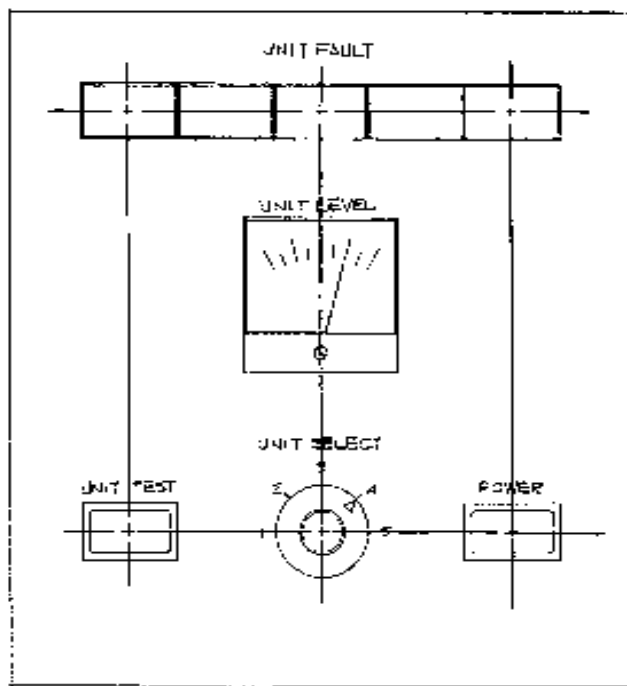

Preferred

Alternative panel layouts. These before-and-after views illustrate how an existing design may be upgraded to better communicate through layout revision and component substitution. Both function and appearance are improved.

For example, the left hand panel uses outline frames to unnecessarily separate related functions. The frames serve merely as a decorative feature and contribute to a crowded look. In the right hand panel, the frames are eliminated, as the components themselves define their functional space.

The uniform use of square and rectangular panel elements in the right hand panel serves to further simplify and harmonize the appearance. Note that the UNIT FAULT indicators and the analog meter are located in the top half of the panel to help prevent the operator's hand from obscuring them when the controls are being used. The POWER switch-indicator combination eliminates the separate POWER ON light. Also, legends appear above their respective components, rather than in the left hand version's random arrangement.

Applying Manual Controls and Displays

GRAPHICS CONSIDERATIONS

Panel graphics need not overwhelm the operator with their size, since they are normally viewed at about arm's length.

Legibility is reinforced when the color chosen for the graphics contrasts strongly with the background. Type is most legible when it is shown as dark lettering on a light panel.

Panel Titles

Titles applied to the panel itself should normally appear above the controls to prevent them from being obscured when a control is in use. An exception would be when panel components must be placed at a height that would block the operator's line of sight to the title.

If different-sized components are used in a horizontal array, pick a common baseline for all their associated titles to avoid a stepped, disorderly look.

Whenever possible, apply graphics directly on the manual controls or lighted indicators themselves. This not only conserves valuable panel space, but enhances overall design flexibility. Recommended graphic colors for component surfaces are white on red, green, and blue; black on yellow and white; and white or black on amber.

Alphanumeric and symbol legends can be added or easily changed merely by replacing a switch or indicator button, lens, or rocker-button operator.

Type Selection. All titles should be composed of a simple sans serif typeface for optimum clarity (see examples, at right). Lettering should be horizontal, never vertical. Type sizes should conform to panel component priorities (refer to typical letter heights for titles in descending order, as shown on page 184).

Avoid abbreviations whenever possible; spell out the entire word. If horizontal space is tight, try condensed type, but use it consistently, not interspersed with a standard width type. Inconsistent use of the type styles, sizes, or line weights add visual "noise" to the overall panel scheme and should be avoided.

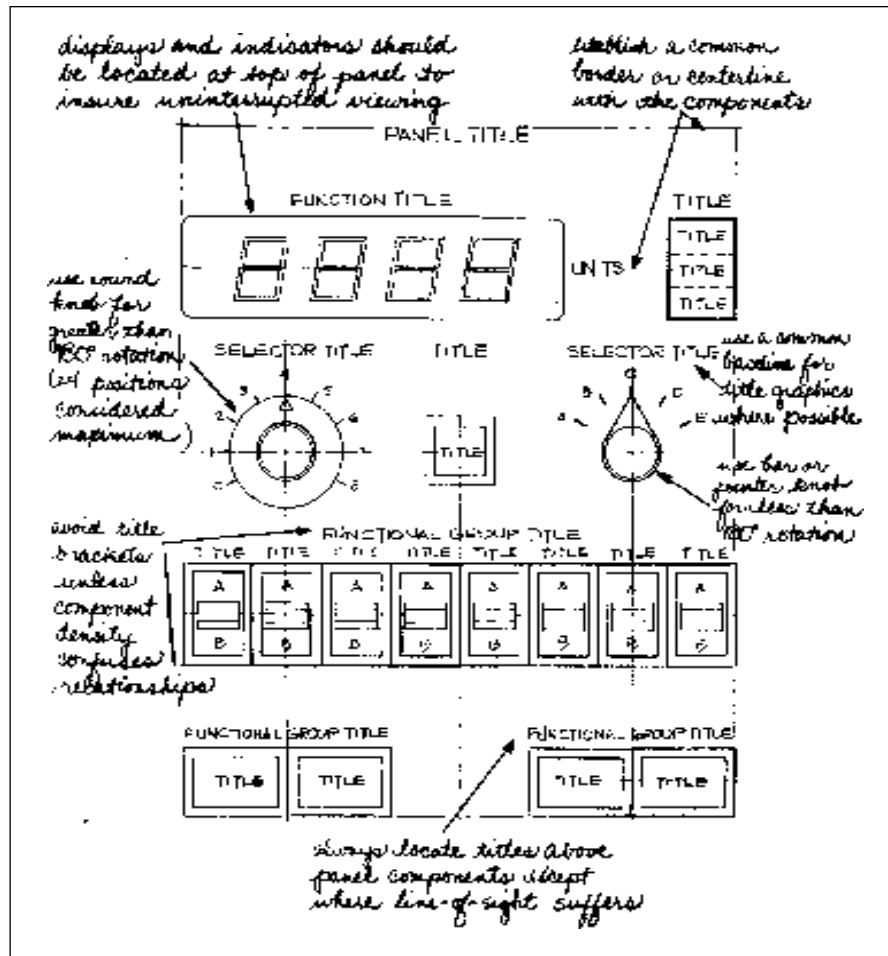

Layout and graphic design considerations

Typeface Examples

Helvetica Medium (This is the preferred type proportion and weight for most titles).

ABCDEFGHIJKLMNOPQRSTUVWXYZ
1234567890

Helvetica Medium Condensed

ABCDEFGHIJKLMNOPQRSTUVWXYZ
1234567890

Helvetica Bold

ABCDEFGHIJKLMNOPQRSTUVWXYZ
1234567890

Applying Manual Controls and Displays

Strip barriers between switches help to prevent inadvertent operation.

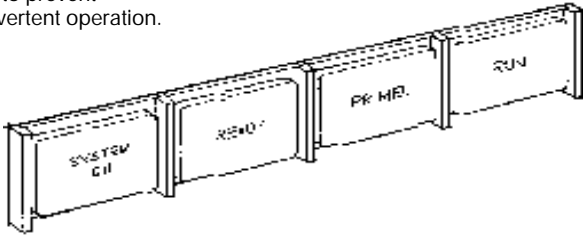

Full barriers surround pushbuttons where more switch protection is desired.

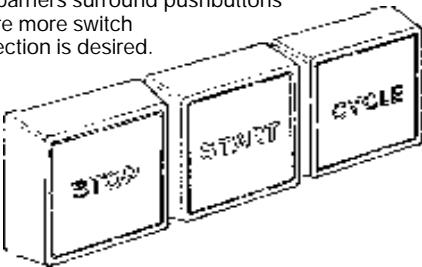

Hinged guards over pushbuttons in high risk control situations. Guards may also be locked for additional security.

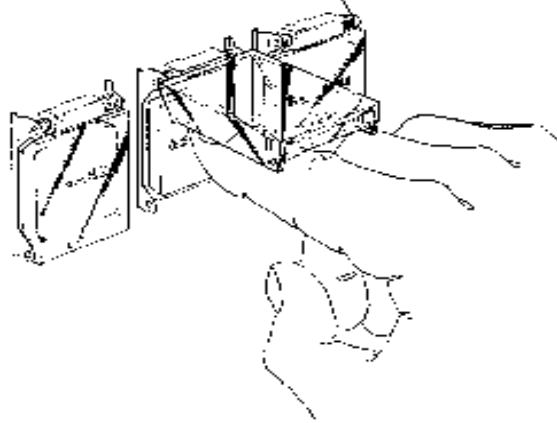

ILLUMINATED COLOR TECHNIQUES

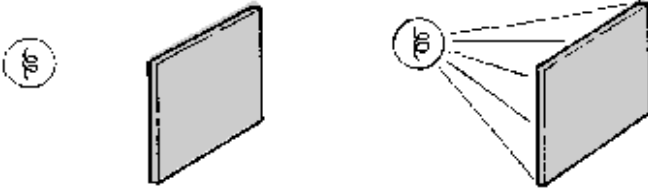

Transmitted color achieved with colored lens (color is visible even when display is unlighted).

Transmitted color refers to the use of colored buttons in applications when the color must be apparent when the display is lighted or unlighted.

Projected color is achieved with a white lens and a color filter/lens. When the lamps are off, the display is white. It becomes colored when illuminated. Though effective in dimly lit or dark rooms, the color signal tends to weaken in high ambient light.

Dead front is a hidden legend/color display which generally uses a transparent, smoky gray lens with a legend on a color insert. The display appears black and un-abrasive when the lamps are off. When illuminated, color and legend appear.

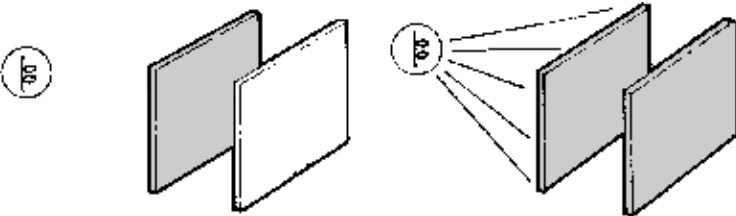

Projected color achieved with colored filter behind white lens (color not visible until lamp is lighted).

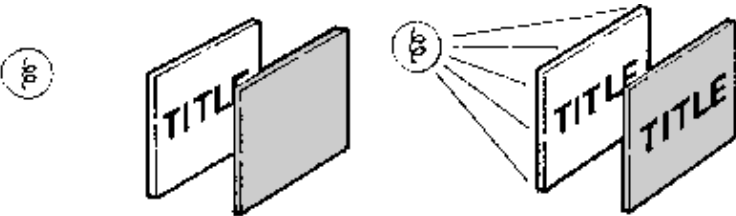

Hidden legend/hidden color (dead front). Dark lens hides color/message until display is lighted.

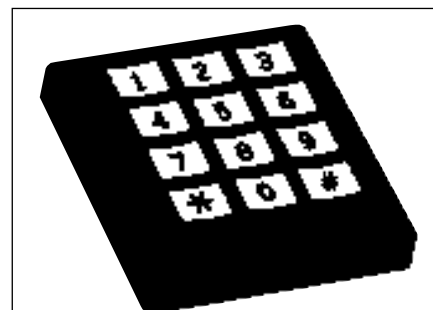

Ready-to-install low-profile push-button matrices can serve as panel elements or an entire panel. Intelligence can be provided by on-board microprocessors which terminate to a plug-in connector.

Applying Manual Controls and Displays

TYPE SIZES

The type sizes chosen should always correspond to the functional priorities of the control panel components, in a descending order, e.g., Panel Title, Group Title, Station Title. Individual application requirements may vary, but grossly oversized letters should be avoided (see drawing).

COLOR CODING

Follow accepted human factor standards when you color code interface components. Since many colors relate to certain well established meanings, e.g., red for STOP, green for GO, they should be used wherever appropriate.

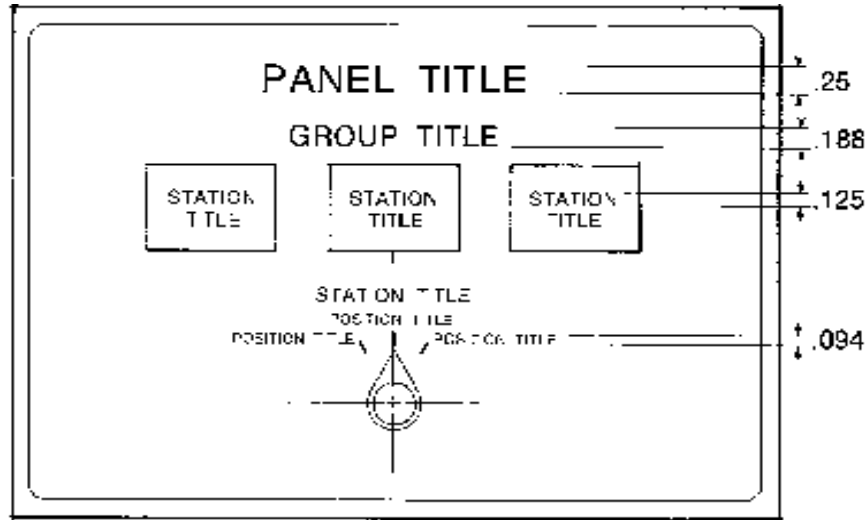

Color	Meanings	Examples
Red	Alerts an operator that an incompatible or dangerous condition exists and corrective action should be taken.	Stop, No-go, Error, Failure, Malfunction, Danger, Warning, Hazard, Take Cover
Yellow	Marginal condition exists	Pressure Below Normal, Check Hopper Level, Caution, Inspection Port Open
Green	Monitored equipment is in tolerance, or a condition is satisfactory and it is all right to proceed	On, Power On,* Go-ahead, Safe, Ready
Blue	May use as an advisory indicator, but has limited coding value; however blue is ideally suited for use at periphery of vision where it can be apparent, but not intrusive	High Beam (automobile headlights)
White	Indicates system conditions or transitions, neither positive nor negative; doesn't imply success or failure	Boiler #1 On Line, Reservoir Cycling

* Note: The power generating industry is an exception, since it traditionally has used the color red to indicate Power On. Their rationale is that red connotes a "hot" electrical condition. However, green is definitely the preferred human factors choice for Power On indication.

PANEL FINISH

Non-reflecting, matte-textured colors from light gray to black, beige, and white will yield a panel that contrasts well with controls and indicators of any color. Neutral color backgrounds will focus attention on the controls. But color effectiveness is muted when interface components are surrounded by a panel of a like or similar color.

When in doubt, keep it simple and in good taste – and you will achieve the most satisfying, long-term results.

FINAL EVALUATION

Prior to finalizing your design, evaluate the total panel layout experimentally. Assess its communication effectiveness with a test situation, using a mock-up or prototype. Describe the application to typical operators, individually.

Observe the procedures used by the operators. If there are basic design errors, they should show up, along with the operator's preferences for certain control features. Separate individual prejudices from valid criticisms. Then apply the data to a revised layout. Check and recheck.

In actual practice, there are normally several revisions made beyond an initial proposal. Rarely, if ever, does the first scheme prove acceptable as the final design; so don't be disheartened when new insights from associates or test results necessitate change. Even after a design goes into production, it is not unusual for revisions to be made because of undiscovered problems.

Manual Switches

Advanced Manual Line

FEATURES

- Complete selection of pushbutton, rocker and paddle (toggle type) switches accommodates different functions and promotes operator efficiency.
- Solid state, electronic, and power duty control.
- Full or split screen incandescent display switches and indicators provide vivid transmitted color, projected color (for neutral display when unlit), and dead front (hidden color).
- Wide-angle visibility LED and line voltage neon display switches and indicators.
- Annunciators back-lighted by LED's enable high density message display.
- Keylock switches available for controlled access applications.
- All AML terminations at the same shallow depth (1.7 in. /43,1 mm) for convenient wiring or PC board termination.
- Snap-in surface mount or sub-panel (hidden bezel) mount with mounting hardware.
- Pad printed legends with a clear polyurethane overcoat available in a choice of five standard sizes.
- Metric design for worldwide acceptance.
- UL recognized, CSA certification.
- Selected listings are certified by VDE, CEE, SEV, and FINKO (for compliance status, contact the 800 number.

MICRO SWITCH AML Advanced Manual Line combines functional flexibility with electrical versatility to provide a broad range of options to choose from.

EASY TO RELAMP



Relamping of T-1-3/4 incandescent AML91 lamps is accomplished from the front of the panel without tools. (AML92 T-1-3/4 LEDs can be added in the same manner.)

FULL GUARD BEZEL OPTION



As an alternative to standard height bezels (.06 in./1,5 mm), pushbutton switches can be furnished with full guard bezels extending .19 in./5.0 mm from the mounting surface. In the free position, standard buttons are flush with full guard bezels.

The raised bezel guards against accidental operation by someone leaning against or dropping something on a control console.

High Intensity LEDs For Full-face AML Lighted Display AML92 Series



- Full-face illumination for high visibility lighted colors.
- Advanced illumination technology combines high-intensity LED in standard T-1-3/4 wedge base lamp package.
- Easy plug-in installation in AML lighted switches and indicators.
- Low operating temperature permits high density, continuous operation with minimal heat build-up.

AML92 Series LEDs have a quad chip assembled in a T-1-3/4 wedge base lamp package. They provide full-face illumination when used with lighted pushbutton, rocker and paddle switches, or indicators equipped with incandescent lamp sockets. For ordering information, refer to page 59.

Manual Switches

Advanced Manual Line

AML Series

AML CHARACTERISTICS

	AML 10 Series	AML 20 Series	AML 30 Series	AML 40 Series
Electrical/Mechanical Life*				N/A
Pushbuttons–Momentary	1,000,000	100,000	25,000	---
Pushbuttons–Alternate	25,000	25,000	25,000	---
Rockers	25,000	25,000	25,000	---
Paddles	25,000	25,000	25,000	---
Agency Ratings (May not apply to every series division)				
UL	File E53576	File E12252	File E12252	File E58932
CSA	File LR4442	File LR4442	File LR4442	File LR4442
VDE	None	File 0630/10.78+ Rating 1710 No. 4275.5788	File 0630/10.78+ + Rating 1710 No. 4275.5788	None

*95% Survival

+ Exception: Four-Pole AML's are not included in VDE Approval

+ + Exception: Only the 2-pole AML33 and AML34 are certified by VDE

AML ELECTRICAL DATA

● AML10 Series

Electrical Characteristics						Absolute Maximum Rating ⁴			
Integrated Circuit Function	Supply Current (Max.)	Output Voltage (Operated)	Output Leakage Current max. (Released)	Switching Time Max.		Supply Voltage (V _s)	Voltage Externally Applied to Output	Loads to Output	Storage Temperature
				Rise 10% to 90%	Fall 90% to 10%				
5 VDC Sinking ¹	3.5 mA (Released) 6.5mA (Operated — no load)	+ .4 Volt (Sinking 8 mA)	2.0 μA	1.0 μsec (Sinking 8 mA)	1.0 μsec (Sinking 8 mA)	-.5 to +7.0 VDC 0° to +65°C (+32° to +149°F)	-.5 Volt min. +15 Volts max. (Off condition)	20 mA (Sinking)	-40°C to +65°C (-40° to +149°F)
6-16 VDC Sinking ²	6.5 mA @ 6 VDC. 10.0 mA @ 16 VDC (Plus load current) ³	+ .4 Volt (Sinking 20mA max.)	20 μA	1.5 μsec (Sinking 20 mA)	0.5 μsec (Sinking 20 mA)	-1.2 to +20 VDC	+20 VDC max. in Off condition only -0.5 VDC min. in Off or On condition.	40 mA	-40°C to +65°C (-40° to +149°F)
4.5-24 VDC Sinking	5 V 7.0 mA (Released) 24 V 9.0 mA (Released) 14.0 mA (Operated-no load)	+ .4 Volt (Sinking 10 mA)	10 μA	1.5 μ sec (Sinking 10 mA)	0.5 μ sec (Sinking 10 mA)	-30 to +30 VDC	-0.5 Volt min. +24 Volts max. (Off condition)	20 mA (Sinking)	-40 – C to +65°C (-40° to +149°F)
5 VDC Scan	3.8 mA @ .6V max. input at Logic "0"	2.4 VDC min. (Sourcing 11 mA)	1.0 μA	1.5 μ sec (Sourcing 5 mA)	1.5 μ sec (Sourcing 5 mA)	-.5 to +7.0 VDC	-.5 VDC min. 7.0 max. (Off Condition)	25 mA (Scan)	-40°C to +65°C (-40° to +149°F)

¹ Over temperature range of 0° to +55°C (+32° to +131°F) and supply voltage of 4.5 to 5.5 VDC.

² Over temperature range of 0° to +55°C (+32° to +131°F) and supply voltage of 16 VDC.

³ At 24°C. (+75°F)

⁴ As with all solid state components, performance can be expected to deteriorate as rating limits are approached; however, they will not be damaged unless the limits are exceeded.

● AML20 Series

Contacts	Voltage	Current	Load Type
Silver or Gold-plated Silver	250 VAC 125 VAC 24 VDC	2 Amps 3 Amps 2 Amps	75% Power Factor 75% Power Factor Resistive
Gold	125 VAC/DC	100 mA	Resistive

● AML30 Series

Voltage	Current		Load Type
	Pushbuttons	Rockers or Paddles	
125 VAC	10 amps	15 amps	60% power factor
250 VAC	10 amps	15 amps	60% power factor

Manual Switches

AML Series

Mounting Dimensions (For Reference Only)

AML31/32 SWITCHES

PUSHBUTTON

Non-Illuminated or Incandescent Lamp Display

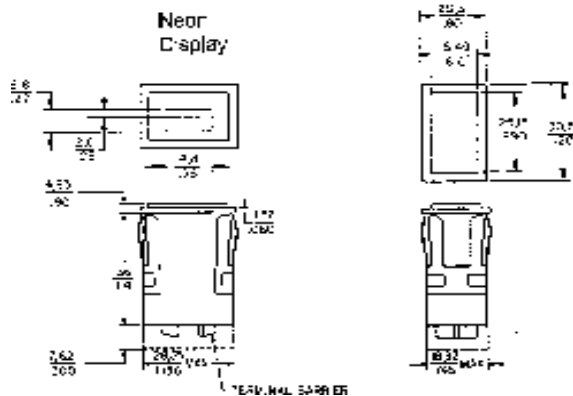

AML34/36 SWITCHES

ROCKER

Non-Illuminated or Incandescent Lamp Display

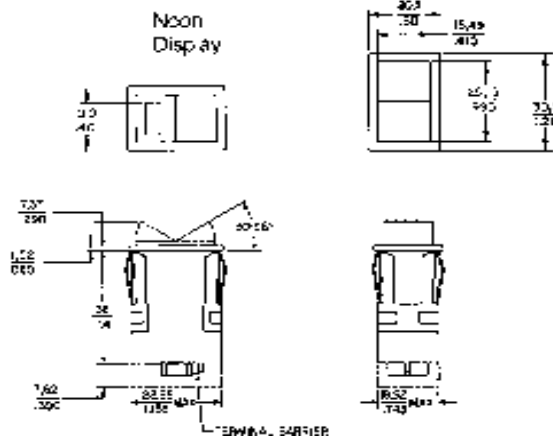

AML33/35 SWITCHES

PADDLE

Neon Location Same as Rocker

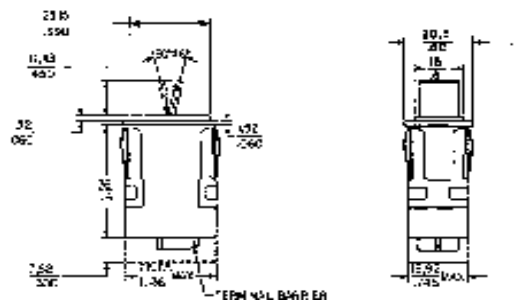

TERMINAL LOCATIONS

PUSHBUTTON

ROCKER AND PADDLE

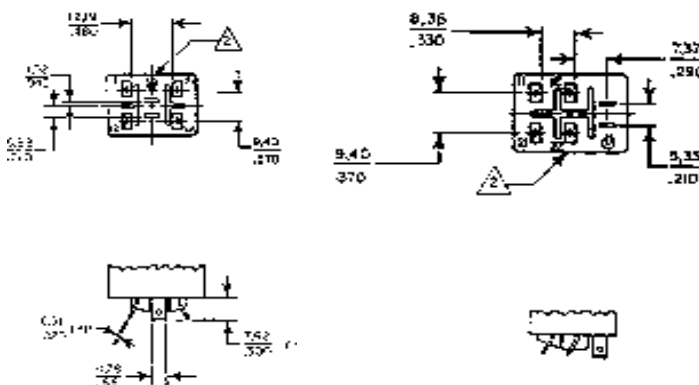

AML43 INDICATORS

Neon Display

Terminal Locations

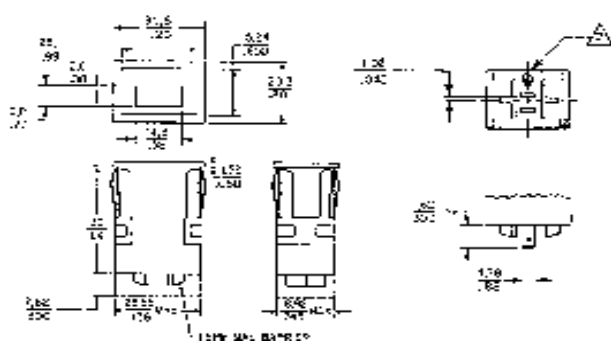

PANEL CUTOUT FOR SINGLE-STATION FRONT-OF-PANEL MOUNTING

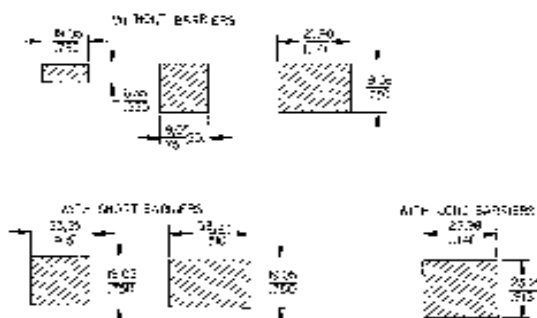

Recommended panel thickness: .060-.187/1,52-4,75

NOTES

1 Dimensions are mm or mm/IN

Manufacturers logo on this side of housing
Solder Hole Will Accept One #14 AWG Stranded Conductor
(Per NEMA Publication DC-2 1976)

PANEL PUNCH FOR AML SERIES

A panel punch is manufactured by Greenlee-Textron Tool Co., Rockford, IL (815-926-3011).

Manuals

Manual Switches

AML Series

Mounting Dimensions (For Reference Only)

TERMINAL LOCATIONS FOR AML10 SWITCHES

PUSHBUTTONS

Solder and Quick-Connect

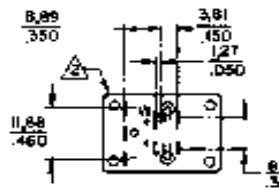
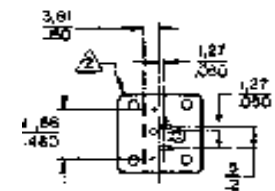

Printed Circuit

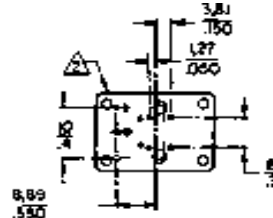
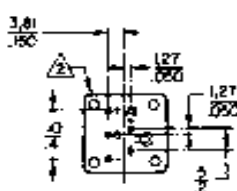

Illuminated devices shown (non-illuminated devices do not have lamp terminals).

ROCKERS AND PADDLES

Solder and Quick-Connect

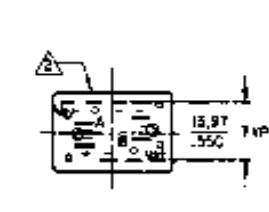
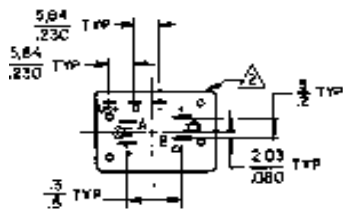

Printed Circuit

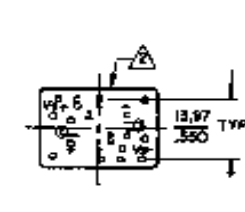
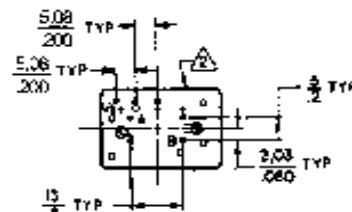

One Integrated Circuit

Two Integrated Circuits

One Integrated Circuit

Two Integrated Circuits

Illuminated devices shown (non-illuminated devices do not have lamp terminals)

TERMINAL LOCATIONS FOR AML41 INDICATORS

Solder and Quick-Connect

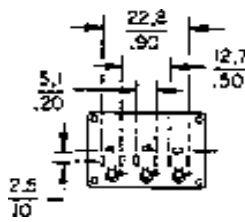
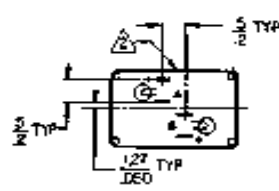
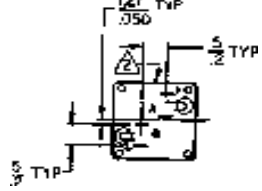
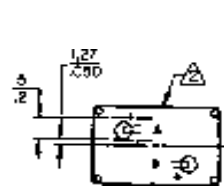
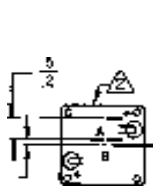

1 Incandescent Lamp Circuit

1 Incandescent Lamp Circuit

2 Incandescent Lamp Circuits

2 Incandescent Lamp Circuits

1-3 Incandescent Lamp Circuits **6**

Printed Circuit

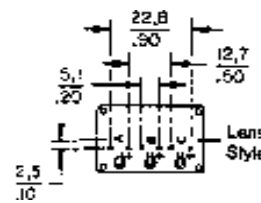
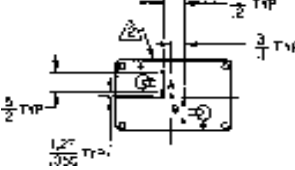
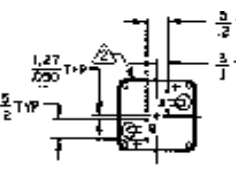
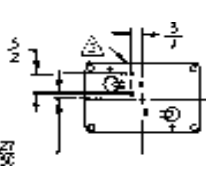
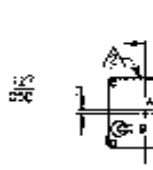

1 Incandescent Lamp Circuit

1 Incandescent Lamp Circuit

2 Incandescent Lamp Circuits

2 Incandescent Lamp Circuits

1-3 Incandescent Lamp Circuits **6**

TERMINAL LOCATIONS FOR AML42 INDICATORS

Solder and Quick-Connect

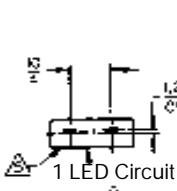
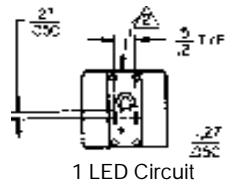

Printed Circuit

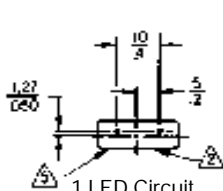
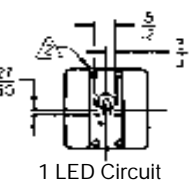

1 LED Circuit

1 LED Circuit

1 LED Circuit

1 LED Circuit

NOTE

- 1 Dimensions are MM or MM/IN
IN
- 2** Manufacturer's logo on this side of housing
- 4 - Lamp terminals are not provided for non-illuminated devices
- 5** positive terminal ident. (+) marked this side of housing
- 6** 1 - lamp termination identified by "B".
2 - lamp termination identified by "A" and "C".

Manual Switches

AML Series

Mounting Dimensions (For Reference Only)

TERMINAL LOCATIONS FOR AML20 SWITCHES

PUSHBUTTON SWITCHES Solder or Quick-Connect

 Terminal identification marked on each adjacent side of housing

KEYLOCK SWITCHES

Solder or Quick-Connect

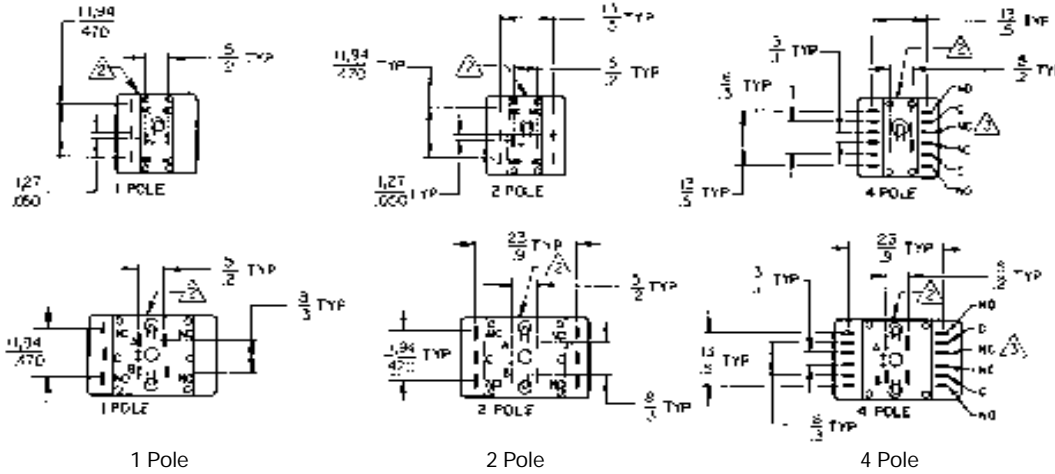

PUSHBUTTON SWITCHES Printed Circuit

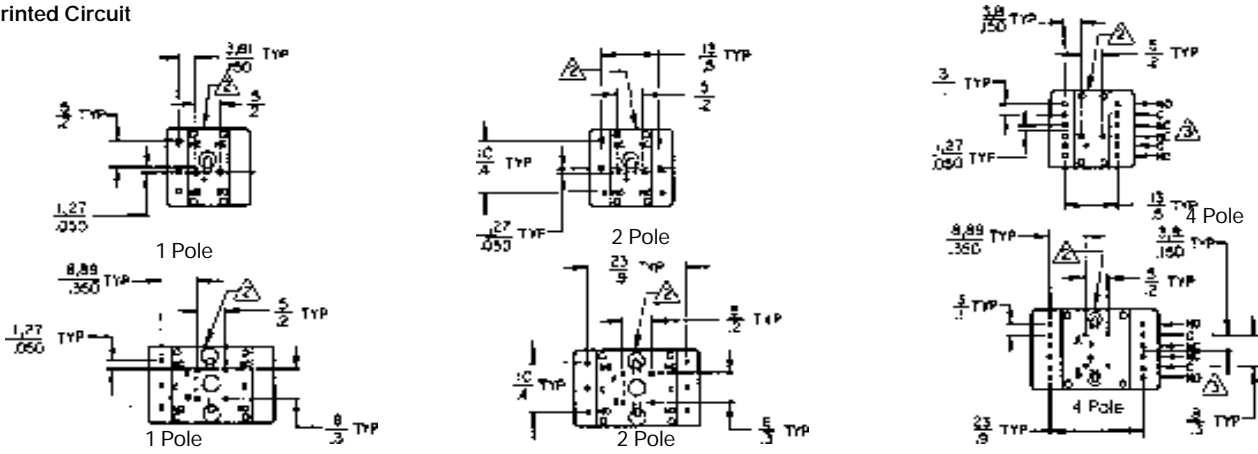

ILLUMINATED ROCKERS AND PADDLES Solder or Quick-Connect

Printed Circuit

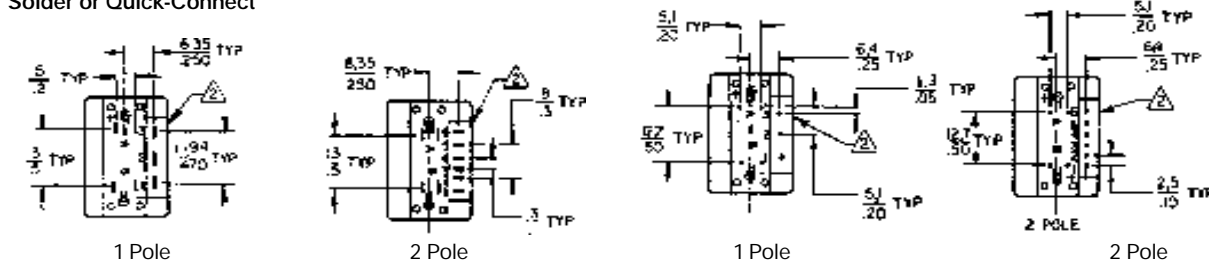

NON-ILLUMINATED ROCKERS AND PADDLES Solder or Quick-Connect

Printed Circuit

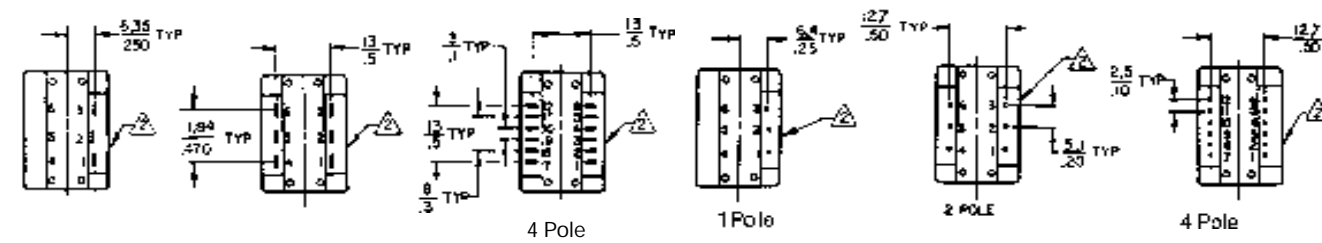

Manuals

Manual Switches

AML Series

Mounting Dimensions (For Reference Only)

ANNUNCIATORS

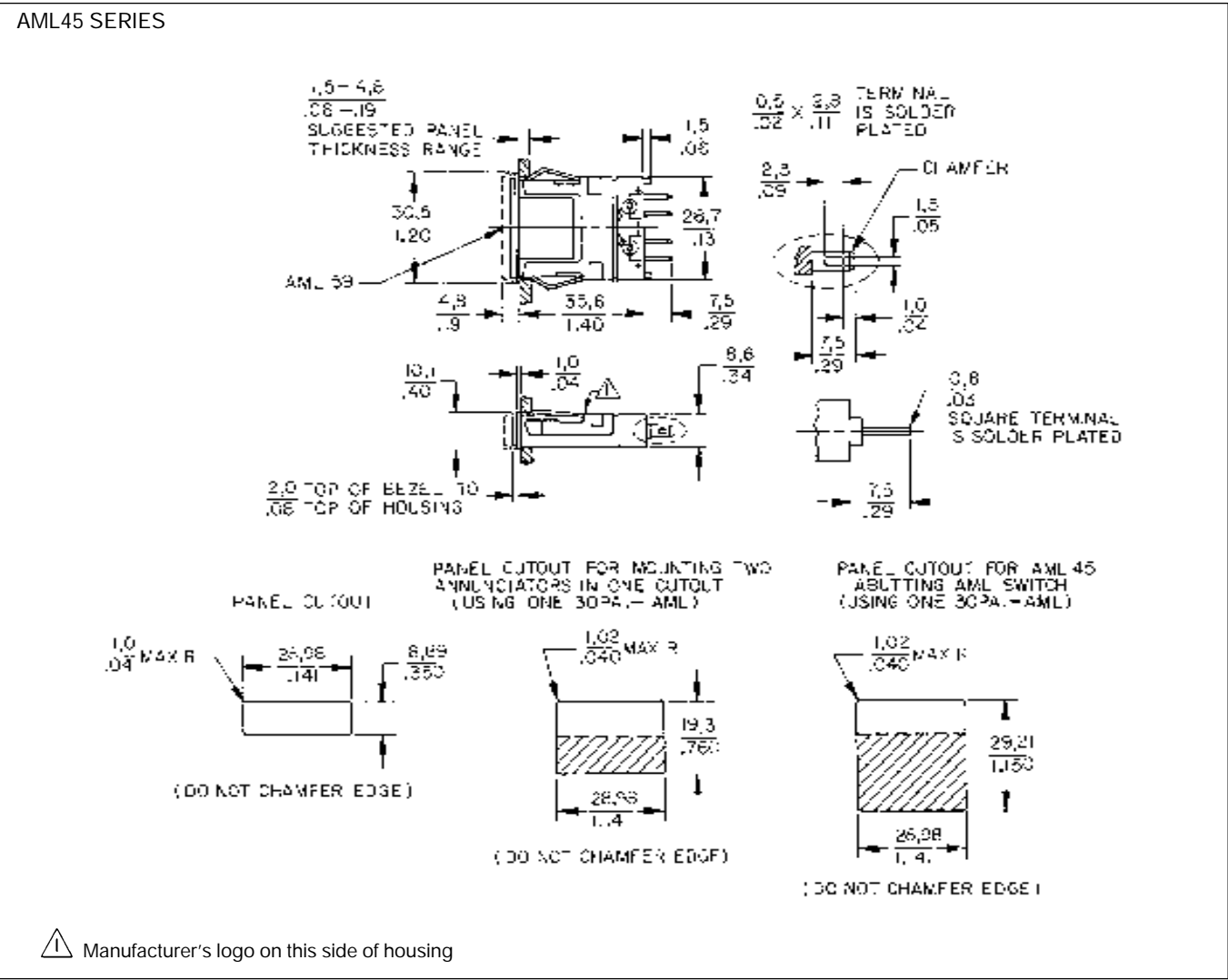

For panel punch manufacturer, see page 61.

Manual Switches

Mounting Dimensions (For Reference Only)

MULTI-STATION FRONT-PANEL MOUNTING

Panel cutouts (See page 61 for panel punch manufacturer.)

Square Switches & Indicators	Rect. Switches & Indicators	Annunciator
(.8) (No. of units) — .045*	(1.20) (No. of units) — .045*	(.40) (No. of units) — .045*
(20,3) (No. of units) — 1,14*	(30,5) (No. of units) — 1,14*	(10,1) (No. of units) — 1,14*

For each barrier, add .053/1,35

* Note: If barriers are used, do not subtract .045 in./1,14 mm from the panel cutout formula. (.045 in./1,14mm is the allowance for the width of the bezel.)

AML61 MULTI-STATION SUBPANEL MOUNTING

Panel cutouts for AML61

Mounting Bracket Orientation	Width	Length
A* in. mm	.810 20,57	(.810)(No. of units)
B in. mm	.810 20,57	(1.210)(No. of units)
C or D* in. mm	1,210 27,94	(.810)(No. of units)

* More than two cans with mounting brackets required for strips of more than 10 units.

AML61 MOUNTING CENTERS

Mounting Bracket Orientation	Mounting Centers/Number of Cans											
	1	2	3	4	5	6	7	8	9	10	11	12
"A" or "C" in. mm	1.285 32,64	2.095 53,21	2.905 73,79	3.715 94,36	4.525 114,94	5.335 135,51	6.145 156,08	6.955 176,66	7.765 197,23	8.575 217,81	9.385 238,38	10.195 258,95
"B" in. mm	1.685 42,80	2.895 73,53	4.105 104,27	5.315 135,00	6.525 165,74	7.735 196,48	8.945 227,20	10.155 257,94				
"D" or "E" in. mm	on C _L on C _L	.807 20,50	1.614 41,00	2.421 61,49	3.228 81,99	4.035 102,49	4.842 122,99	5.649 143,48	6.456 163,98	7.263 184,48	8.070 204,98	8.877 225,48

Tolerance = ±.015

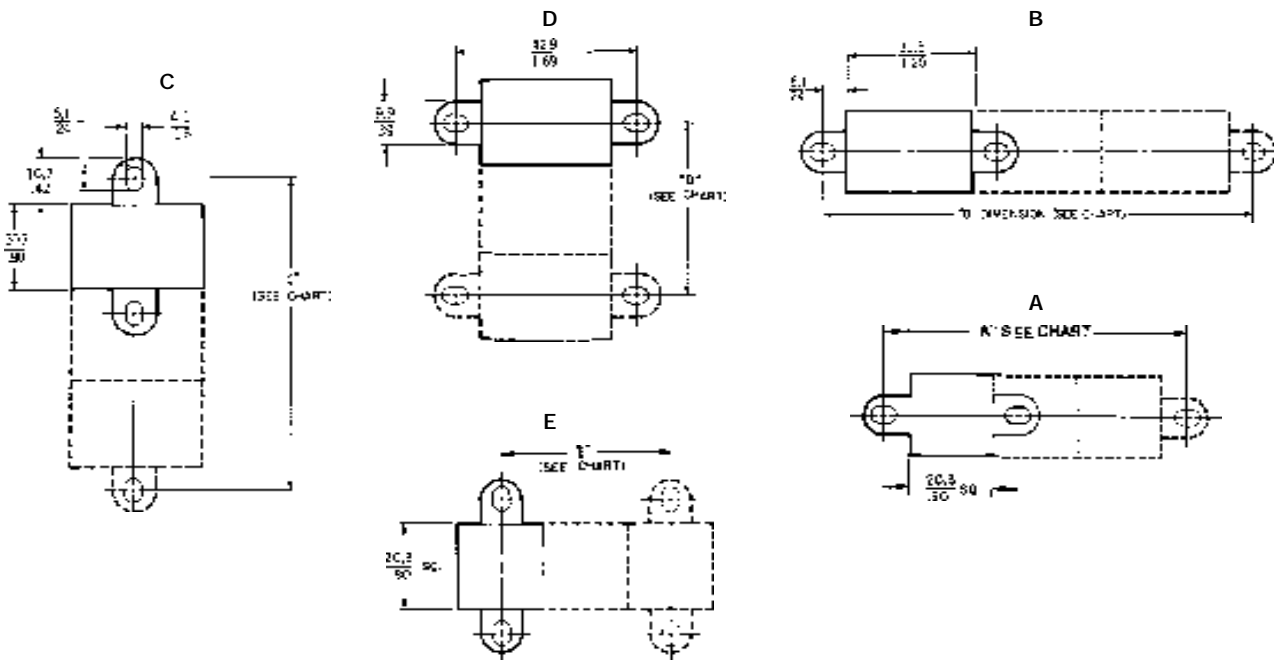

Manuals

Manual Switches

Mounting Dimensions (For Reference Only)

AML75 PANEL SEAL ACCESSORY

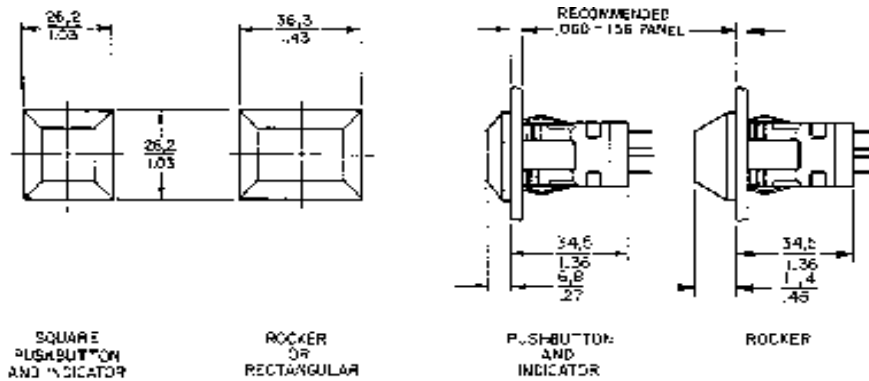

Panel cutouts

Multiple panel sealed units should not be mounted together in a single elongated slot, since this would create an unsealed space between each unit.

Side-by-side mounting can be achieved, per the center-to-center dimensions shown in the drawing. (Dotted lines indicate the seal bases which are abutting at front of panel.)

AML75 seals are not designed for use with the AML61 mounting system.

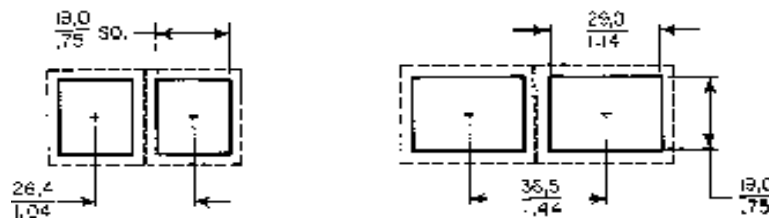

NOTE: Suggested cutout dimensions are based on an .125"/3,18 mm panel thickness. Individual preferences for inpanel fit

may require measurement of assemblies before panels are cut.

AML76 SWITCH GUARD ACCESSORY

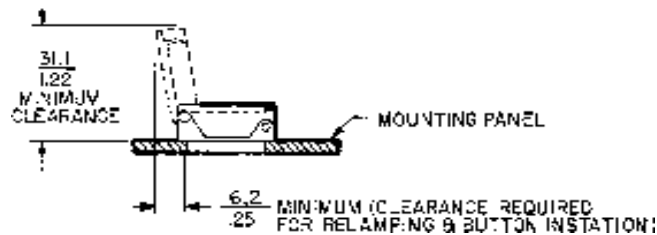
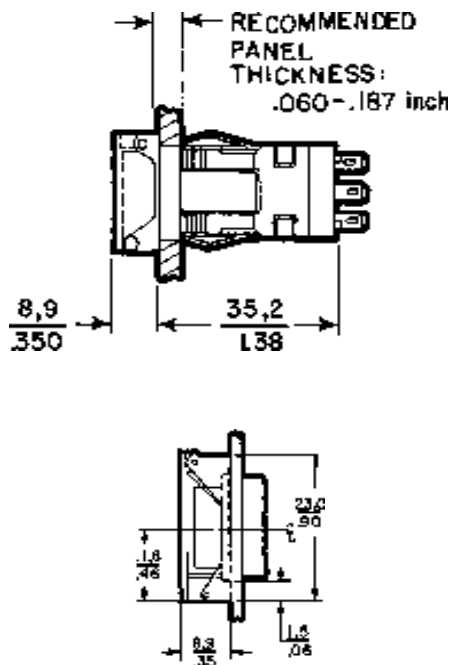

PANEL CUTOUTS

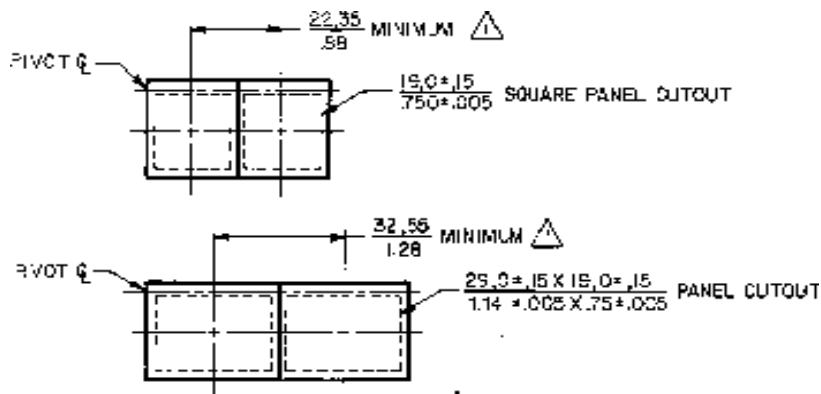

MINIMUM DIMENSION ALLOWED FOR MOUNTING GUARDS SIDE BY SIDE

Manual Switches

Solid State Pushbutton

AML11 Series

INCANDESCENT OR NON-LIGHTED DISPLAY



Buttons ordered separately.

FEATURES

- Hall effect reliability.
- Provides low voltage signals that interface with nearly all DC logic level loads.
- 5 VDC, 6-16 VDC and 4.5-24 VDC supply voltage.
- Full guard bezel option.
- Lamps can be furnished installed or ordered separately.
- UL recognized.
- Lamp circuit independent of switch circuit.

AML11 ORDER GUIDE

AML11 B

Housing Type	
Standard Bezel:	
AML11B	Square Non-Lighted
AML11C	Square 1 Lamp Ckt.
AML11E	Rect. Non-Lighted
AML11F	Rect. 1 Lamp Ckt.
AML11G	Rect. 2 Lamp Ckts.
Full Guard Bezel:	
AML11H	Square Non-Lighted
AML11J	Square 1 Lamp Ckt.
AML11K	Rect. Non-Lighted
AML11L	Rect. 1 Lamp Ckt.
AML11M	Rect. 2 Lamp Ckts.

Bezel Color	
B	Black

Incandescent Lamp Type	
A	No Lamp Installed
B	6 V Lamp*
C	14 V Lamp*
E	28 V Lamp*

Terminal Type	
2	.110 × .020 (Solder or Quick-Connect)
3	.025 × .025 (Printed Circuit, or Push-On)

Circuitry Codes		
5 VDC Sinking	AA Momentary Action	AE Alternate Action
6-16 VDC Sinking	BA Momentary Action	BE Alternate Action
5 VDC Scan**	CA Momentary Action	CE Alternate Action
4.5-24 VDC Sinking	DA Momentary Action	DE Alternate Action

* Lamps will be installed per each lamp circuit specified in the Housing Type.

** See "Scan Switches," next page.

Example: **AML11BBA2AA**

Square pushbutton switch housing, non-lighted; black bezel; .110 × .020 termination; momentary action; current sinking output for use with 5 volt supply.

CURRENT SINKING OUTPUT AML10 SERIES

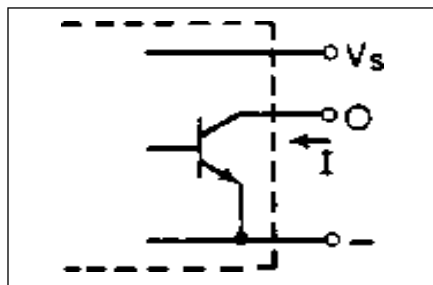

A permanent magnet plunger moves adjacent to the Hall effect integrated circuit to give a digital, current sinking normally high output.

Manual Switches

Solid State Pushbutton

AML12 Series

LED DISPLAY



LED "window" buttons ordered separately.
LEDs are not replaceable.

FEATURES

- Hall effect reliability (Refer to facing page for electrical specifications.)
- Rectangular, high efficiency LED's give flush display area and wide angle indication.
- Available with or without diode protection for the LED's.
- 5 thru 24 VDC devices have an internal resistor to maintain LED current at nominal 20 mA.

Electrical Data	Page 20
Buttons	Page 43, 44
Lamps and LEDs	Page 59
Accessories	Page 57, 58
Mounting Dimensions	Page 60, 62

- LED circuit independent of switch circuit.
- UL recognized.

AML12 ORDER GUIDE

AML12C

Housing Type
Standard Bezel: AML12C Square 1 LED
Full Guard Bezel: AML12J Square 1 LED

B

Bezel Color
B Black

B

LED Color/ Voltage
Red
B V*
C 5 V
D 10 V
E 15 V
F 24 V
Yellow
H V*
J 5 V
K 10 V
L 15 V
M 24 V
Green
R V*
S 5 V
T 10 V
W 15 V
X 24 V

2

Terminal Type/ Diode Protection
2 .110 x .020 (Solder or Quick-Connect)
3 .025 x .025 (Printed Circuit or Push-On)
8 .110 x .020 With Diode Protection

AA

Circuitry Codes		
5 VDC Sinking	AA Momentary Action	AE Alternate Action
6-16 VDC Sinking	BA Momentary Action	BE Alternate Action
5 VDC Scan**	CA Momentary Action	CE Alternate Action
4.5-24 VDC Sinking	DA Momentary Action	DE Alternate Action

* See LED application information for devices without current-limiting resistor, page 59.

Example: **AML12CBB2AA**

Square pushbutton switch housing; black bezel; red LED; .110 x .020 termination; current sinking output for use with 5 volt supply; momentary action.

AML11/12 HALL EFFECT SCAN SWITCHES

Scan switches interface directly with a port expander and microcomputer to operate either in a scan matrix or as an individual function switch with a level sourcing signal (emitter follower). Scanning is used to look at each switch in a matrix to see which stations are active. The scan matrix significantly lowers overall power consumption, since each switch requires power only while being strobed.

In the scanned mode, the minus supply connection becomes the scanning input connection. When this input is high, the switch is de-energized and does not consume power. When the scan input is low, the switch will draw current as it normally does when energized. If the button is depressed when the scan input is low, the output will be high. The output remains low if the button is not depressed during the scan cycle.

ELECTRICAL DATA

Circuitry

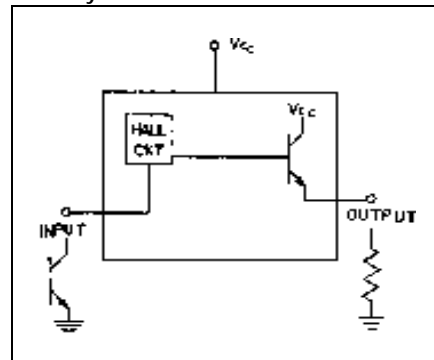

Termination

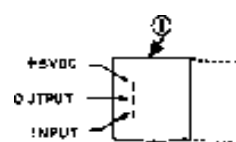

Dotted lines denote rectangular housing.
Ⓞ The "MICRO SWITCH" identification is shown on this side of the switch housings.

Manual Switches

Solid State Paddle

AML13 Series

INCANDESCENT OR NON-LIGHTED DISPLAY

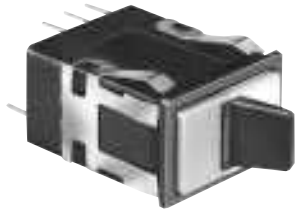

Covers ordered separately.

FEATURES

- Hall effect reliability.
- Provides low voltage signals that interface with nearly all DC logic level loads.
- 5 VDC and 6-16 VDC supply voltage.
- 2 or 3-position operation.
- Toggle type paddle operators permanently installed in rectangular housings.
- Covers for the switch housing may be lighted or unlighted.
- UL recognized.
- Lamps can be furnished installed or ordered separately.
- Lamp circuit independent of switch circuit.

AML13 ORDER GUIDE

AML13 E	B	A	2	AA	01
Housing Type	Operator/Bezel Color	Incandescent Lamp Type	Terminal Type	Circuitry Code	Operating Action
AML13 E Rectangular Non-Lighted AML13 F Rectangular 1 Lamp Ckt. (A) AML13 G Rectangular 2 Lamp Ckts. (A & B)	B Black/Black 	A No Lamp Installed B 6 V Lamp* C 14 V Lamp* E 28 V Lamp*	2 .110 x .020 (Solder or Quick-Connect) 3 .025 x .025 (Printed Ckt., or Push-On)	One IC (Ckt. A): AA 5 V Sinking BA 6-16 V Sinking DA 4.5-24 VDC Sinking Two IC's (Ckts. A & B): AC 5 V Sinking BC 6-16 V Sinking DC 4.5-24 VDC Sinking	Insert Code Numbers from Operating Action Chart

* Lamps will be installed per each lamp circuit specified in the Housing Type.

Example: **AML13EBA2AA01**
Rectangular non-lighted paddle switch housing; black paddle and bezel; .110 x .020 terminals; with one 5 V sinking IC pack; two position operation.

OPERATING ACTION

2 Position:		
Maint.	01 None	Maint.
Mom.	02 None	Maint.
Maint.	03 None	Mom.
3-Position:**		
Maint.	04 Maint.	Maint.
Mom.	05 Maint.	Mom.
Maint.	06 Maint.	Mom.
Mom.	07 Maint.	Maint.

** 3-position switches must have two circuits specified in the listing (circuitry codes "AC" or "BC").

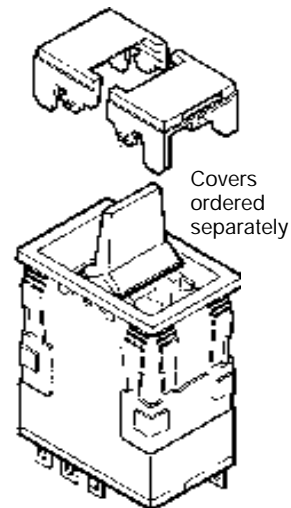

Manuals

Manual Switches

Solid State Paddle

AML15 Series

LED DISPLAY



Covers with LED "window" ordered separately.

LEDs are not replaceable.

FEATURES

- Hall effect reliability.
- Rectangular, high efficiency LED's give flush display area and wide angle indication.
- Available with or without diode protection for the LED's.
- 5 thru 24 VDC devices have an internal resistor to maintain LED current at nominal 20 mA.
- LED circuit independent of switch circuit.
- UL recognized.

Electrical Data	Page 20
Paddle Covers	Page 48, 49
Lamps	Page 59
Accessories	Page 57, 58
Mounting Dimensions	Page 60, 62

AML15 ORDER GUIDE

AML15 F	B	B	2	AA	01	R	X
Housing Type	Operator Bezel Color	LED Voltage	Terminal Type/ Diode Protection	Circuitry Code	Operating Action	LED Color (LED A)	LED Color (LED B)
AML15 F Rect. 1 LED	B Black/Black	B V*	2 .110 × .020 (Solder or Quick-Connect)	One IC (Ckt. A): AA 5 V Sinking	Insert Code Numbers from Operating Action Chart	R Red	R Red
AML15 G Rect. 2 LED's		C 5 V	3 .025 × .025 (Printed Circuit, or Push-On)	BA 6-16 V Sinking		Y Yellow	Y Yellow
		D 10 V	8 .110 × .020 w/Diode Protection for LED	DA 4.5-24 VDC Sinking		G Green	G Green
		E 15 V		Two IC's (Ckts. A & B): AC 5 V Sinking		X No LED	X No LED
		F 24 V		BC 6-16 V Sinking			
				DC 4.5-24 VDC Sinking			

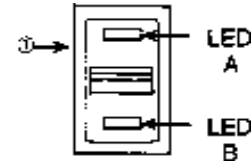

* See LED application information for devices without current-limiting resistor, page 59.

Example: AML15FBB2AA01RX

Rectangular paddle switch housing with one LED, without resistor, black paddle and bezel; .110 × .020 terminals, with one 5 V sinking IC pack; 2-position operation.

CIRCUIT OUTPUT STATES

Ckt. A	Low (operated)	High	High
Ckt. B	High	High	Low (operated)

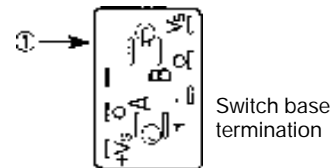

① The "MICRO SWITCH" identification is on this side of the switch housing.

Manual Switches

Electronic Control Pushbutton

AML21 Series

INCANDESCENT OR NON-LIGHTED DISPLAY



Buttons ordered separately.

FEATURES

- 1, 2, or 4 poles.
- Silver or gold contacts.
- Full guard bezel option.
- Momentary or 2-level alternate action (push-on, push-off).
- UL recognized, CSA certified.
- Lamps can be furnished installed or ordered separately.
- Lamp circuit independent of switch circuit.



AML21 Series: 1 pole and 2-pole only.

AML21 ORDER GUIDE

AML21 B

Housing Type	
Standard Bezel:	
AML21B	Square Non-Lighted
AML21C	Square 1 Lamp Ckt.
AML21E	Rect. Non-Lighted
AML21F	Rect. 1 Lamp Ckt.
AML21G	Rect. 2 Lamp Ckts.
Full Guard Bezel:	
AML21H	Square Non-Lighted
AML21J	Square 1 Lamp Ckt.
AML21K	Rect. Non-Lighted
AML21L	Rect. 1 Lamp Ckt.
AML21M	Rect. 2 Lamp Ckts.

Bezel Color
B Black

Incandescent Lamp Type
A No Lamp Installed
B 6 V Lamp*
C 14 V Lamp*
E 28 V Lamp*

Terminal Type
2 .110 × .020 (Solder or Quick-Connect)
3 .025 × .025 (Printed Ckt. or Push-On)

Circuitry Codes (Each pole has double-throw)	
Silver Contacts	Mom. Action AA 1-Pole AC 2-Pole CC 4-Pole
	Alt. Action AB 1-Pole AD 2-Pole CD 4-Pole
Gold Contacts	Mom. Action BA 1-Pole BC 2-Pole DC 4-Pole
	Alt. Action BB 1-Pole BD 2-Pole DD 4-Pole
Gold-Plated Silver Contacts	Mom. Action EA 1-Pole EC 2-Pole
	Alt. Action EB 1-Pole ED 2-Pole

* Lamps will be installed per each lamp circuit specified in the Housing Type.

Example: AML21BBA2AA

Square pushbutton switch housing non-lighted; black bezel; .110 × .020 termination; momentary action; 1-pole, double-throw; silver contacts.

Manuals

Manual Switches

Electronic Control Pushbutton

AML22 Series

LED DISPLAY



Buttons with LED "window" ordered separately.
LEDs are not replaceable.

FEATURES

- Identical to AML21 switches, except furnished with high efficiency LED display.
- Rectangular LED's are flush with button surface, providing wide angle indication.
- Optional diode protection for LED's.
- 5 thru 24 VDC LED devices have an internal resistor to maintain current at nominal 20 mA.
- UL recognized, CSA certified.
- LED circuit independent of switch circuit.

Electrical Data	Page 20
Buttons	Page 43, 44
Lamps	Page 59
Accessories	Page 57, 58
Mounting Dimensions	Page 60, 63



AML22 Series: 1 pole and 2-pole only.

AML22 ORDER GUIDE

AML22 C		B	B	2	AA	
Housing Type		Bezel Color	LED Color/ Voltage	Terminal Type	Circuitry Codes (Each pole has double-throw)	
Standard Bezel: AML22C Square 1 LED AML22H Square 1 High-Profile LED (For use with AML52-A buttons)		B Black	Red B V* C 5V D 10V E 15V F 24V Yellow H V* J 5V K 10V L 15V M 24V Green R V* S 5V T 10V W 15V X 24V	2 .110 × .020 (Solder or Quick-Connect)	3 .025 × .025 (Printed Ckt., or Push-On)	Silver Contacts Mom. Action AA 1-Pole AC 2-Pole CC 4-Pole Alt. Action AB 1-Pole AD 2-Pole CD 4-Pole
Full Guard Bezel: AML22J Square 1 LED						
		Gold-Plated Silver Contacts Mom. Action EA 1-Pole EC 2-Pole Alt. Action EB 1-Pole ED 2-Pole				

* See LED information for devices without current limiting resistor, page 59.

Example: AML22CBB2AA

Square pushbutton switch housing with one LED, black bezel; red LED (without resistor); .110 × .020 termination; momentary action, 1-pole, double-throw; silver contacts.

CONTACT ARRANGEMENT

1, 2 or 4 poles: Form C



Manual Switches

Electronic Control Paddle

AML23 Series

INCANDESCENT OR NON-LIGHTED DISPLAY

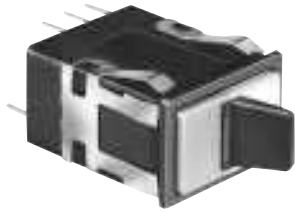

Covers ordered separately.

FEATURES

- Silver or gold contacts.
- 1, 2 or 4 poles.
- Toggle type paddle operators permanently installed in rectangular housings.
- Covers for the switch housing may be lighted or unlighted.
- UL recognized, CSA certified.
- Lamps can be furnished installed or ordered separately.
- Lamp circuit independent of switch circuit.

Electrical Data	Page 20
Paddle Covers	Page 48
Lamps	Page 59
Accessories	Page 57, 58
Mounting Dimensions	Page 60,63



AML23 Series: 1 pole and 2-pole only.

AML23 ORDER GUIDE

AML23 E	B	A	2	AA	01
Housing Type	Operator/Bezel Color	Incandescent Lamp Type	Terminal Type	Circuitry Codes	Operating Action
AML23 E Rectangular Non-Lighted AML23 F Rectangular 1 Lamp Ckt. (A) AML23 G Rectangular 2 Lamp Ckts. (A & B)	B Black/Black	A No Lamp Installed B 6 V Lamp* C 14 V Lamp* E 28 V Lamp*	2 .110 × .020 (Solder or Quick-Connect) 3 .025 × .025 (Printed Ckt., or Push-on)	Insert Code letters as shown in Circuitry Chart	Insert Code numbers from Operating Action Chart

* Lamps will be installed per each lamp circuit specified in the Housing Type.

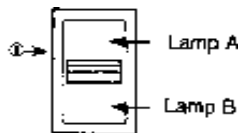

① The "MICRO SWITCH" identification is shown on this side of the switch housings.

Example: **AML23EBA2AA01**
 Rectangular non-lighted paddle switch housing; black paddle and bezel; .110 × .020 terminals; with one circuit ON and one circuit OFF in each extreme operator position (maintained).

Manuals

CIRCUITRY

Silver Contacts	Gold Contacts	2-Position	3-Position	
AA	BA			
AC	BC			
CA	DA			
CC	DC			

OPERATING ACTION

2-Position:		
Maint.	01 None	Maint.
Mom.	02 None	Maint.
Maint.	03 None	Mom.
3-Position:		
Maint.	04 Maint.	Maint.
Mom.	05 Maint.	Mom.
Maint.	06 Maint.	Mom.
Mom.	07 Maint.	Maint.

Manual Switches

Electronic Control Rocker

INCANDESCENT OR NON-LIGHTED DISPLAY



FEATURES

- Silver or gold contacts.
- 2 or 3 position operation.
- UL recognized, CSA certified.
- Lamps can be furnished installed or ordered separately.
- Lamp circuit independent of switch circuit.

Electrical Data	page 19
Rockers	page 51
Lamps	page 58
Accessories	pages 56, 57
Mounting Dimensions	pages 59, 62



*AML24 Series: 1 pole and 2-pole only.

Rocker operators ordered separately.

AML24 ORDER GUIDE

AML24 E	B	A	2	AA	01
Housing Type	Bezel Color	Incandescent Lamp Type	Terminal Type	Circuitry Codes	Operating Action
AML24 E Rectangular Non-Lighted AML24 F Rectangular 1 Lamp Ckt. (A) AML24 G Rectangular 2 Lamp Ckts.	B Black	A No Lamp Installed B 6 V Lamp* C 14 V Lamp* E 28 V Lamp*	2 .110 × .020 (Solder or Quick-Connect) 3 .025 × .025 (Printed Ckt., or Push-on)	Insert Code letters as shown in Circuitry Chart	Insert Code numbers from Operating Action Chart

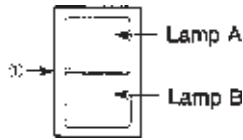

* Lamps will be installed per each lamp circuit specified in the Housing Type.

① The "MICRO SWITCH" identification is shown on this side of the switch housings.

Example: **AML24EBA2AA01**

Rectangular non-lighted rocker switch housing; black bezel; .110 × .020 terminals; with one circuit ON and one circuit OFF in each extreme operator position (maintained).

CIRCUITRY

Silver Contacts	Gold Contacts	2-Position		3-Position			
AA	BA						
AC	BC						
(Non-illuminated switches only)							
CA	DA						
CC	DC						
(Non-illuminated switches only)							

OPERATING ACTION

2-Position:		
Maint.	01 None	Maint.
Mom.	02 None	Maint.
Maint.	03 None	Mom.
3-Position:		
Maint.	04 Maint.	Maint.
Mom.	05 Maint.	Mom.
Maint.	06 Maint.	Mom.
Mom.	07 Maint.	Maint.

Manual Switches

Electronic Control Paddle

AML25 Series

LED DISPLAY



Covers with LED "window" ordered separately.

FEATURES

- Identical to AML23, except furnished with one or two rectangular high efficiency LED's which give flush display area and wide angle indication.
- Available with or without diode protection for LED's.
- LED circuit independent of switch circuit.
- 5 thru 24 VDC devices have internal resistor to maintain current at nominal 20 mA.
- UL recognized, CSA certified.



AML25 Series: 1 pole and 2-pole only.

AML25 ORDER GUIDE

AML25 F	B	B	2	AA	01	R	X
Housing Type	Operator/ Bezel Color	LED Voltage	Terminal Type/ Diode Protection	Circuitry Codes	Operating Code	LED Color (LED A)	LED Color (LED B)
AML25 F Rectangular 1 LED AML25 G Rectangular 2 LED's	B Black/Black	B V* C 5 V D 10 V E 15 V F 24 V	2 .110 × .020 (Solder or Q-C) 3 .025 × .025 (Printed Ckt., or Push-On) 8 .110 × .020 w/Diode protection	Insert code letters as shown in Circuitry Chart on p. 29 LED version available only with AA BA CA DA circuitry	Insert code numbers from Operating Action Chart on p. 29	R Red Y Yellow G Green X No LED	R Red Y Yellow G Green X No LED

* See LED application information for devices without current-limiting resistor, page 59.

Example: **AML25FBB2AA01RX**
 Rectangular paddle switch; illuminated with one red LED, this device has a black paddle and bezel, and .110 × .020 terminals; with one circuit ON and one circuit OFF in each extreme operator position (maintained).

† For further information on replacement LED's, call the 800 number.

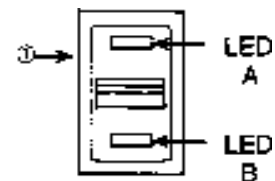
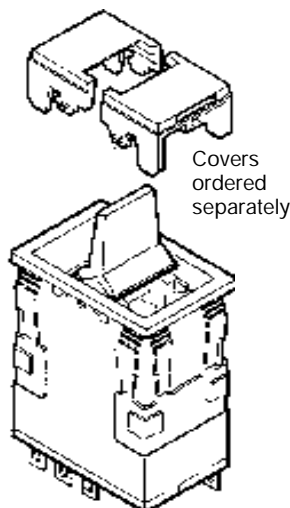

① The "MICRO SWITCH" identification is shown on this side of the switch housings.

Manual Switches

Electronic Control Rocker

LED DISPLAY



Rocker operators ordered separately.

LEDs are not replaceable.

FEATURES

- Identical to AML24, except furnished with one or two rectangular high efficiency LED's which give flush display area and wide angle indication.
- Available with or without diode protection for LED's.
- LED circuit independent of switch circuit.

Electrical Data	page 19
Rockers	page 52
Lamps and LEDs	page 58
Accessories	page 57
Mounting Dimensions	pages 59, 62

- 5 thru 24 VDC LED devices have internal resistor to maintain current at nominal 20 mA.
- UL recognized, CSA certified.



*AML26 Series: 1 pole and 2-pole only.

AML26 ORDER GUIDE

Housing Type	Bezel Color	LED Voltage	Terminal Type/ Diode Protection	Circuitry Codes	Operating Action	LED Color (LED A)	LED Color (LED B)
AML26 F 1 LED	B Black	B V*	2 .110 × .020 (Solder or Quick-Connect)	Insert code letters as shown in Circuitry Chart	Insert code numbers from Operating Action Chart	R Red	R Red
AML26 G 2 LED's		C 5 V	3 .025 × .025 (Printed Ckt., or Push-On)	LED version available only with		Y Yellow	Y Yellow
		D 10 V	8 .110 × .020 w/Diode for LED protection	AA BA CA DA circuitry		G Green	G Green
		E 15 V				X No LED	X No LED
		F 24 V					

*See LED application information for devices without current-limiting resistor, page 58.

Example: **AML26FBB2AA01RX**
Rectangular rocker switch; illuminated with one LED, this device has a black bezel, .110 × .020 terminals; with one circuit ON and one circuit OFF in each extreme operator position (maintained).

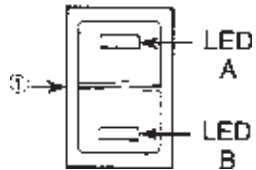

① The "MICRO SWITCH" identification is shown on this side of the switch housings.

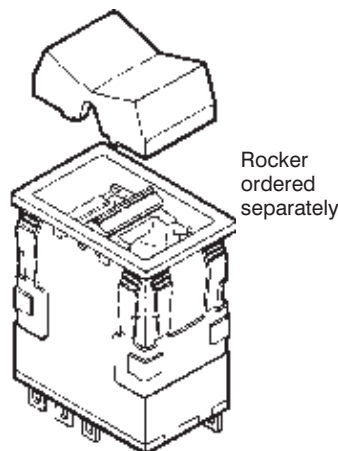

Rocker ordered separately

Manuals

Manual Switches

Power Duty Pushbutton

AML31/32 Series

INCANDESCENT, NEON, OR NON-LIGHTED DISPLAY

- FEATURES**
- UL recognized, CSA certified.
 - AML31 lamp circuit independent of switch circuit.

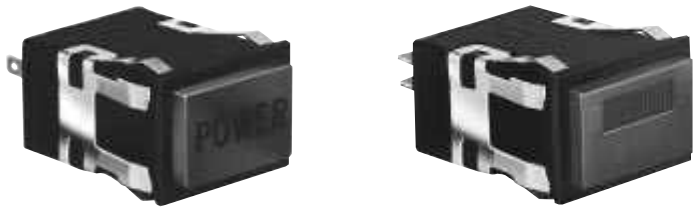

AML31 Series: 2-pole.
AML32 Series: 2-pole.

Buttons ordered separately.

CONTACT ARRANGEMENT

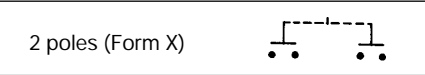

AML31 ORDER GUIDE

AML31 accepts one incandescent lamp which can be furnished installed or ordered separately.

AML31 E	B	A	4	AC
Housing Type	Bezel Color	Incandescent Lamp Type	Terminal Type	Circuitry Codes
Standard Bezel: AML31E Rect. Non-Lighted AML31F Rect. 1 Lamp Ckt. Full Guard Bezel: AML31K Rect. Non-Lighted AML31L Rect. 1 Lamp Ckt.	B Black	A No Lamp Installed B 6 V Lamp* C 14 V Lamp* E 28 V Lamp*	4 .187 × .020 (Solder or Quick-Connect)	2-Pole, Single-Throw Normally-Open, Form X: AD AC Alt. Mom. Action Action

* Lamps will be installed per each lamp circuit specified in the Housing Type.

Example: **AML31EBA4AC**
 Rectangular pushbutton switch housing, non-lighted; black bezel; .187 × .020 terminals; momentary action; 2-pole, single-throw, normally open, Form X.

AML32 ORDER GUIDE

AML32 has neon lamp wired to 125 or 250 VAC resistor.

AML32 F	B	C	7	AC
Housing Type	Bezel Color	Neon Lamp Voltage/Color	Terminal Type Lamp Circuit	Circuitry Codes
Standard Bezel: AML32F Rect. 1 Neon Lamp Full Guard Bezel: AML32L Rect. 1 Neon Lamp	B Black	Red B 125 VAC C 250 VAC Clear K 125 VAC L 250 VAC Green M 125 VAC P 250 VAC	4 .187 × .020 (Solder or Quick-Connect) with isolated lamp circuit 7 .187 × .020 with integral lamp circuit	2-Pole, Single-Throw Normally-Open, Form X: AD AC Alt. Mom. Action Action

Example: **AML32FBC7AC**
 Rectangular pushbutton switch housing; black bezel; 250 volt, red neon lamp; .187 × .020 terminals with integral lamp circuit; momentary action; 2-pole, single-throw, normally open, Form X.

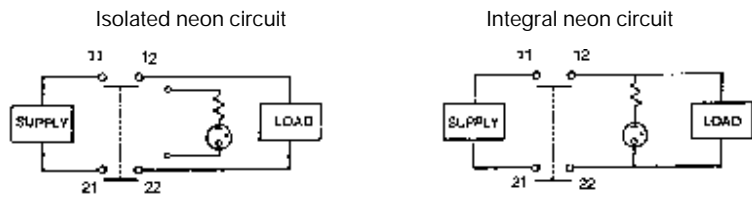

Manual Switches

Power Duty Paddle

AML33/35 Series

INCANDESCENT, NEON, OR NON-LIGHTED DISPLAY

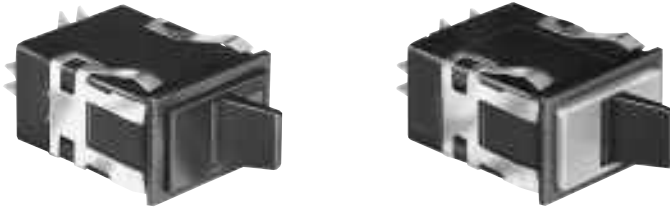

Colored housing covers ordered separately.

Electrical Data	Page 20
Paddle Covers	Page 48
Lamps	Page 59
Mounting Dimensions	Page 61

FEATURES

- Toggle type paddle operators permanently installed in rectangular housings.
- 2-position maintained action.
- AML33 lamp circuit independent of switch circuit.
- UL recognized, CSA certified.



AML33 Series: 2-pole only.
AML35 Series: 1-pole and 2-pole.

CONTACT ARRANGEMENT

1 or 2 poles: Form A



AML33 ORDER GUIDE

AML33 accepts one incandescent lamp which can be furnished installed or ordered separately.

AML33 E	B	A	4	AA	01
Housing Type	Operator/Bezel Color	Incandescent Lamp Type	Terminal Type	Circuitry Codes	Operating Action
AML33 E Rectangular Non-Lighted AML33 F Rectangular 1 Lamp Ckt.	B Black/Black 	A No Lamp Installed B 6 V Lamp* C 14 V Lamp* E 28 V Lamp*	4 .187 × .020 (Solder or Quick-Connect)	Silver Contacts: AA 1-Pole (One Form A Single-throw, Normally-Open) AC 2-Pole (Two Form A)	 01 Maint. ON Maint. OFF

* Lamps will be installed per each lamp circuit specified in the Housing Type.

AML35 ORDER GUIDE

AML35 has neon lamp wired to 125 or 250 VAC resistor.

AML35 F	B	B	4	AA	01
Housing Type	Operator/Bezel Color	Neon Lamp Voltage	Terminal Type/ Lamp Circuit †	Circuitry Codes	Operating Action
AML35 F Rectangular 1 Neon Lamp	B Black/Black 	Red B 125 VAC C 250 VAC Green M 125 VAC P 250 VAC	4 .187 × .020 (Solder or Quick-Connect) With Isolated Lamp Circuit 7 .187 × .020 With Integral Lamp Circuit (Available with 2-Pole devices only)	Silver Contacts: AA (One Form A Single-Throw) Available only with isolated lamp circuit, term. type 4. AC 2-Pole (Two Form A)	 01 Maint. ON Maint. OFF

① The "MICRO SWITCH" identification is shown on this side of the switch housing.
† Refer to next page for neon lamp circuit schematics.

Example: **AML35FBB4AA01**

Rectangular paddle switch housing; black paddle and bezel; 125 VAC neon lamp; .187 × .020 terminals with isolated

lamp circuit; 1-Pole Form A Single-Throw; with circuit ON in one extreme position and OFF in the other (maintained).

Manuals

Manual Switches

Power Duty Rocker

AML34/36 Series

INCANDESCENT, NEON, OR NON-LIGHTED DISPLAY

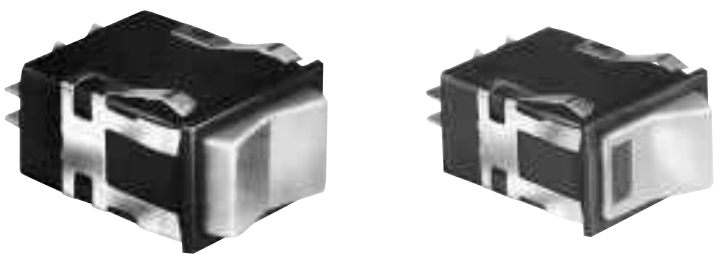

Rocker operators ordered separately.

FEATURES

- Same circuitry, and electrical rating as power duty paddle switches.
- Neon lamp circuitry can be isolated or integral on 2-pole switches; isolated-only on 1-pole switches (see schematics).
- UL recognized, CSA certified.
- AML34 lamp circuit independent of switch circuit.



AML34 Series: 2-pole only.
AML36 Series: 1-pole and 2-pole.

AML34 ORDER GUIDE

AML34 accepts one incandescent lamp which can be furnished installed or ordered separately.

AML34 E	B	A	4	AA	01
Housing Type AML34 E Rectangular Non. Illum. AML34 F Rectangular 1 Lamp Ckt.	Bezel Color B Black	Incandescent Lamp Type A No Lamp Installed B 6 V Lamp* C 14 V Lamp* E 28 V Lamp*	Terminal Type 4 .187 x .020 (Solder or Quick-Connect)	Circuitry Codes Silver Contacts: AA 1-Pole (One Form A Single-Throw) AC 2-Pole (Two Form A)	Operating Action  01 Maint. ON Maint. OFF

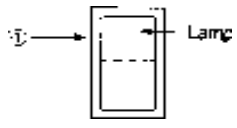

* Lamps will be installed per each lamp circuit specified in the Housing Type.

AML36 ORDER GUIDE

AML36 has neon lamp wired to 125 or 250 VAC resistor.

AML36 F	B	B	4	AA	01
Housing Type AML36 F Rectangular 1 Neon Lamp	Bezel Color B Black	Neon Lamp Voltage Red B 125 VAC C 250 VAC Green M 125 VAC P 250 VAC	Terminal Type/ Lamp Circuit 4 .187 x .020 (Solder or Quick-Connect) With Isolated Lamp Circuit 7 .187 x .020 (Solder or Quick-Connect) With Integral Lamp Circuit	Circuitry Codes Silver Contacts: AA (One Form A Single-Throw) Not available with terminal type 7 AC 2-Pole (Two Form A)	Operating Action  01 Maint. ON Maint. OFF

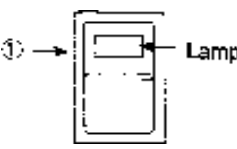

① The "MICRO SWITCH" identification is shown on this side of the switch housing.

Example: **AML36FBB4AA01**
Rectangular rocker switch housing; black bezel; 125 VAC neon lamp; .187 x .020 terminals with isolated lamp circuit; 1-Pole Form A single-throw; with circuit ON in one extreme position and OFF in the other.

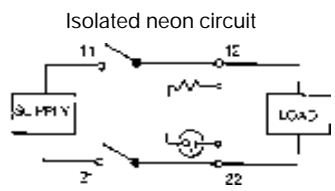
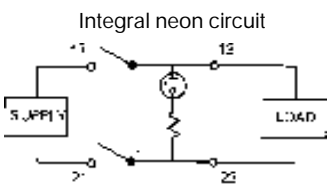

Manual Switches

Lighted Indicators

AML41/42/43 Series

To order lamps see page 59.

FEATURES

- Pushbutton style indicators match display of lighted switches. Choice of incandescent, LED, or neon illumination.
- Lens style indicators use a special cap-like button which covers the bezel to present a larger display area, without affecting family appearance. Up to 3-lamp split screen capability. Incandescent illumination.



AML41
(Use AML51 push-buttons only.
Page 43.)



AML41
(Use AML51-J/-K/-L lens buttons only.
Page 43.)

AML41 INCANDESCENT DISPLAY INDICATORS ORDER GUIDE

AML41 C		B	A	2
Housing Type		Bezel Color	Incand. Lamp Type	Terminal Type
Pushbutton Style:	Lens Style:			
AML41 C Square 1 lamp ckt.	AML41 J Rectangular 1 lamp ckt.	B Black	A No lamp installed	2 .110 × .020 (Solder or Quick-Connect)
AML41 D Square 2 lamp ckts.	AML41 K Rectangular 2 lamp ckts.		B 6 V Lamp*	3 .025 × .025 (Printed Circuit or Push-On)
AML41 F Rectangular 1 lamp ckt.	AML41 L Rectangular 3 lamp ckts.		C 14 V Lamp*	
AML41 G Rectangular 2 lamp ckts.			E 28 V Lamp*	

* Lamps will be installed per each lamp circuit specified in the Housing Type.

Examples:

AML41CBA2

Square (pushbutton style) indicator housing with one lamp circuit; black bezel; .110 × .020 termination.

AML41JBA2

Rectangular (lens style) indicator housing with one lamp circuit; black bezel; .110 × .020 termination.



AML42C
(Use AML52-C/-A pushbuttons only.
Page 44.)



AML42S

AML42 LED DISPLAY INDICATORS ORDER GUIDE

LEDs are not replaceable.

AML42 S	B	C	2	
Housing Type	Bezel Color	LED Color/Voltage	Terminal Type/ Diode Protection	
AML42 C Square 1 LED	B Black	Red B V* C 5 V D 10 V E 15 V F 24 V	2 .110 × .020 (Solder or Q.C.)	8 .110 × .020 w/diode to protect LED
AML42 S Compact 1 LED	Yellow H V* J 5 V K 10 V L 15 V M 24 V	Green R V* S 5 V T 10 V W 15 V X 24 V	3 .025 × .025 (Printed Circuit or Push-On)	9 .025 × .025 w/diode to protect LED

Example: **AML42SBC2**

Compact indicator with black bezel; 5 volt red LED; .110 × .020 termination.

* See LED application data, page 59, for these devices without current-limiting resistor.

Manuals

AML43 neon display indicators are identical to AML32 power switches, except button is furnished assembled (locked in depressed position) and there is no provision for switching. Button is nonremovable. Other button colors are available.

Example:

AML43FBB40R

Rectangular device with black bezel; 125 volt red neon lamp .187 × .020 termination.

NOTE: Add **L** to neon indicator catalog listing if legend is desired and submit Legend Sheet FO-63504.

AML43 NEON DISPLAY INDICATORS ORDER GUIDE

AML43 F	B	B	4	OR
Housing Type**	Bezel Color	Neon Lamp Color/Voltage	Terminal Type	Button Color
AML43F Rect.	B Black	Red B 125 V C 250 V Clear K 125 V L 250 V Green M 125 V P 250 V	4 .187 × .020 (solder or Q.C.)	OR Red OY Yellow OG Green OW White OK Black

Maual Switches

Solid State LED Annunciators

AML59 CAP ASSEMBLIES

The cap assembly consists of: black cap, color filter(s), and optional film legend; furnished unassembled. It snaps onto housing, flush with the housing bezel.

Filters, assembled with their matte finish facing the LED's, efficiently diffuse the illumination. They are color-tinted to complement the red, yellow, and green LED's.

NOTE: Cap assembly should not be subjected to the temperature and chemical atmosphere associated with wave soldering. These parts should be installed after soldering and cleanup.

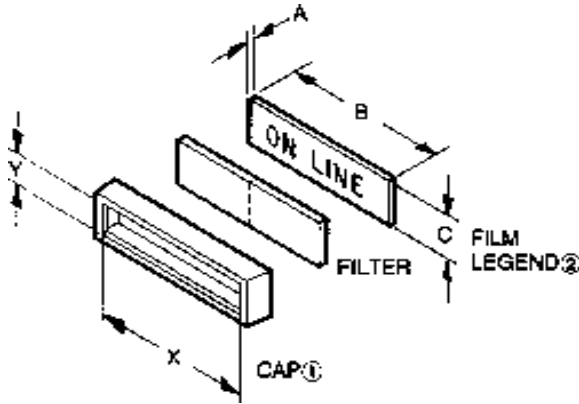

Catalog listings for AML59 cap assemblies are derived from the ordering guide below. The ordering guide for AML45 LED housings is on page 39.

CUSTOM LEGENDS

A 2:1 drawing in black ink is required for satisfactory reproduction of custom film legends. As an alternative, you may submit an office copy of a page from a typographic supplier catalog such as Chartpak, Letraset, and Zipatone. MICRO SWITCH can also furnish graphic legends from the "Henry Dreyfus Symbol Source Book." (Custom legends require a one-time start-up charge.)

- ① Viewing area inside cap:
X = 1.04 min.; Y = .272 min.
- ② Customers ordering film legends from commercial photographic or typesetting sources should specify that the film be precision cut, per the following dimensions, to insure proper retention and alignment on the face of the annunciator: A = .007 max.; B = 1.1 ± .010; C = .300 ± .003.

STANDARD LEGENDS

AML59 Legend Sheet (see page 42) provides ordering information for negative and positive standard film legends in the type style (14-point Helvetica condensed bold) shown below. Use separate legend sheet for each AML59 catalog listing and attach it (them) to your purchase order.

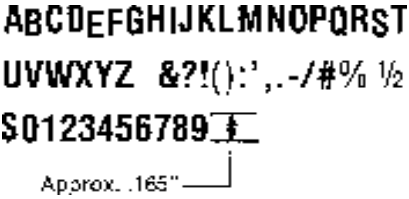

AML59 ORDER GUIDE

AML59-R		K	10	R		
Cap Style		Cap Color	Legend Type	Filter Color		
AML59-R Full Screen		K Black	10 No Legend	Full Screen	Split Screen	
AML59-S Split Screen			20 Negative Film Legend	R Red	R Red	R Red
Y Yellow	Y Yellow		Y Yellow			
G Green	G Green	G Green				

Manuals

Examples:
AML59-RK10R
 Full screen style, black cap, no legend, and red filter.

AML59-SK20RY
 Split screen style, black cap, negative film legend, red and yellow color filters.

Honeywell

AML59 Legend Sheet

Account NO _____

Use this form to describe film legends to be used with AML59 Series Cover Assemblies

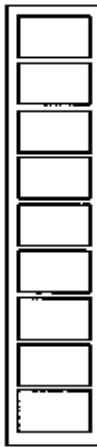
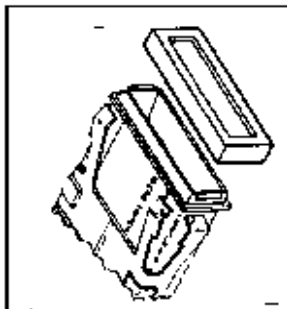

Style "R" (Full Screen)

Special Direction _____

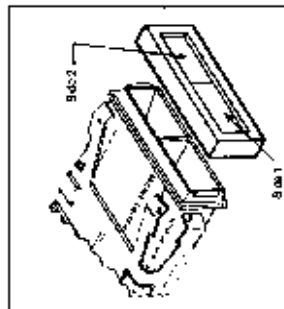

Style "S" (Split Screen)

Special Direction _____

Catalog Listing AML59 -	Quantity Ordered
P.O. No.	Line No.
Schedule No.	Customer Part No.
	Customer Dwg. No.

Customer: _____

Address: _____ (city) _____ (state)

INSTRUCTIONS:

1. Please use black ink to fill in shaded areas.
2. Fill in appropriate catalog listing. - One listing per sheet.
3. Fill in quantity ordered and your order no.
4. Indicate legends desired - do not exceed 9 characters for style "R" or 4 characters on either side of style "S".
5. This completed form must accompany your purchase order

NOTES:











- Legends must be designed to properly assemble to housings, which are to be installed with the MICRO SWITCH logo "up".
- All legends will be centered unless special directions are given.
- Standard legends are 14 pt. helvetica, condensed - Bold. A thru Z and numerals 0 thru 9 are standard.
- Legend Type:
 - Type "20" **NEGATIVE**
 - Type "21" **POSITIVE**

Manual Switches

Buttons/Lens for Switches and Indicators

AML51 PUSHBUTTON ORDER GUIDE

For Incandescent or non-lighted display switches and pushbutton style indicators.

AML51-C	10	R	=
For AML11, 21, 31 switches and AML41 indicators: Pushbutton Style	Display Legend/Type	Full Color or 1st Color Split	2nd Color Split
 AML51-C  AML51-F  AML51-G  AML51-A  AML51-H  AML51-N*  AML51-B*  AML51-E*  AML51-M*  AML51-R*	Transmitted Color 10 No legend 20 With legend on cap. Transmitted Color (Clear cap and color insert) 11 No legend 21 With legend on insert Dead Front (Smoky gray cap and color insert) 30 No legend 40 With legend on insert Projected Color (White cap and color insert) 50 No legend 60 With legend on cap	R Red Y Yellow G Green B Blue W White K*** Black L*** Gray A** Amber	R Red Y Yellow G Green B Blue W White K*** Black L*** Gray A** Amber
For AML41D indicators only:  AML51-D			

* Available with transmitted color (10 or 20) only.

Example: **AML51-C10R**

Square full color button; with transmitted color, no legend: red.

** Available with transmitted color and dead front only.



*** Black and gray not recommended for lighted display.

* AML51-N buttons not available with Display/Legend Types 10 and 20.

Note: Dimensions include the .060 in bezel.

AML51 LENS ORDER GUIDE

For incandescent display AML41J, K, and L lens style indicators only.

AML51-J	10	R		
Lens style	Display/Legend Type	Full Color or 1st Color Split	2nd Color Split	3rd Color Split
 AML51-J  AML51-K  AML51-L	Transmitted Color 10 No legend 20 With legend Transmitted Color (Clear cap and color insert) 11 No legend 21 With legend Dead Front (Smoky gray cap and color insert) 30 No legend 40 With legend Projected Color (White cap and color insert) 50 No legend 60 With legend	R Red Y Yellow G Green B Blue W White A** Amber	R Red Y Yellow G Green B Blue W White A** Amber	R Red Y Yellow G Green B Blue W White A** Amber

** Not available with projected color.

AML51 lens buttons provide added display area by snapping onto and covering the bezel of AML41J, K, and L indicators. They do not fit other indicators or switches.

Example: **AML51-J10R**

Rectangular lens type button; full color; transmitted color, no legend; red.

HOW TO ORDER BUTTON LEGENDS

When specifying legended buttons, submit a legend order sheet to cover each listing. To insure proper legend orientation, AML housings (when viewed from the panel front) should have the "MICRO SWITCH" identification facing UP on square devices and UP or to the LEFT on rectangular.

Button legend order sheets are shown on the following pages. Reproduce them on your office copier.

Legend Sheet	Form No.
AML51 Pushbuttons	FO-63394
AML51 Lens buttons	FO-63395
AML52 Pushbuttons	FO-63504
AML53 Paddle switch covers	FO-63567
AML55 Paddle switch covers	FO-63565
AML54 Rockers	FO-63566
AML56 Rockers	FO-63564

Manual Switches

Buttons for Switches and Indicators

AML52 BUTTON ORDER GUIDE

For AML12, AML22 (w/o light pipe), AML32, AML42 LED display.

AML52-N

10

R

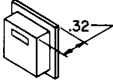
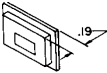
Button Type
<p>For LED Devices AML52-C</p> 
<p>AML52-A*</p> 
<p>For AML32 Neon Devices AML52-N</p> 

Display/Legend Type
<p>Transmitted Color</p> <p>10 No Legend</p> <p>20 With Legend</p>

Button Color
R Red
Y Yellow
G Green
B Blue
W White
K Black
A Amber
L Gray

Examples:

AML52-N10R

Rectangular full screen; for use on neon power switch with transmitted color, no legend; red button.

AML52-C10K

Square full screen; for use with LED device; transmitted color, no legend; black button.

Honeywell

AML Pushbutton Legend Sheet

Account NO. 126 - 2B4

LEGEND ORDER GUIDE

Button Type Orientation	Figure NO	Max Lines/Area			Max Characters/Line		
		5/84	7/84	9/84	13/84	5/16	5/16
1	A ^B	4	3	3	2	1	1
2	PR	4	3	2	2	1	1
3	C	4	3	2	2	1	1
4	D	1	1	1	0	0	0
5	E ^H	4	3	3	2	1	1
6	E ^{H*}	6	4	4	3	2	2
7	F	4	3	2	2	1	1
8	G ^N	1	1	1	0	0	0
9	M	5	4	3	2	1	1

Definitions of Markings

- Two holes to snap into indicator housings
- Internal reliefs to snap over switch plunger tabs

Standard Legend Placement -

- Use special legends sec. for other placements
- 1. Transmitted Color - Legend on outer shell (Button)
- 2. Deep Front - Legend on inset
- 3. Projected Color - Legend on outer shell (Button)
- 4. Transmitted color with clear cap legend on inset

LEGEND ORDER CHART

Customer Part No	Fig No	Type Size	Ink Color	Button Qty
		5/84 7/84 3/84 13/84 5/16	Black White	1 2
				1 2
				1 2
				1 2
				1 2
				1 2

Company Name
AML51

Customer P.O. No. _____ Customer Dept. No. _____

Micro Switch Sales Order _____ Line Number _____

Controls Inc. _____

Customer: _____

Address: _____

City: _____ State: _____ Zip: _____

Instructions

1. Fill in appropriate catalog listing - one listing/sheet.
2. Check proper figure #, Type size, Type color.
3. Fill in quantity required.
4. Indicate legends desired - Do not exceed maximums shown in legend order guide.

Note

1. For Proper Legend Orientation, AML housings (when viewed from front of panel) should have "MICRO SWITCH" logo oriented "UP" on square devices and "UP" or to the "LEFT" on rectangular devices.
2. Please use black ink in filling out this form to help us process your order.
3. INSERT ONLY ON STYLE A & H BUTTON

A3 Modified Gothic

Manifold Gothic including (A thru Z), numbers 0 thru 9 and Symbols below available in 5/84, 7/84, 9/84, 13/84 and 5/16.

!	?	~	^	^	&
;	:	'	'	'	'
;	:	'	'	'	'
\$	#	%	o	+	-
→	↑	↓	←	CR	1/4H/2/3/4/1/3
					2/3 @ ∞

SPECIAL LEGENDS

NOTE: Use this area to show special Legend Locations or Configurations NOT shown to the left. NON STANDARD legends will incur additional charges and increased delivery time.

Fig. "A" _____ Fig. "B" _____

Sheet prepared by: _____

Signature: _____

Date: _____

Manual Switches

Covers for Paddle Switches

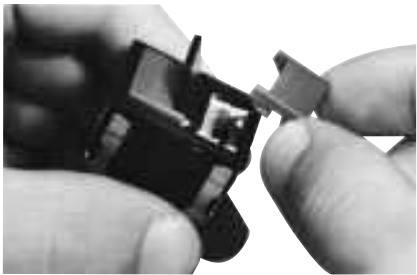

Colored covers simply snap into the top of paddle switch housings.

COLOR DISPLAY OPTIONS



Transmitted color — Color is displayed whether lamp is On or Off. Choice of 1-piece covers (types 10 or 20) or covers with clear cap and colored translucent insert (types 11 or 12).

Projected color — Translucent white cover with transparent colored insert (types 50 or 60). White cover appears colored when illuminated.

Dead front hidden color/hidden legend — Cover appears black with lamp Off. Legend and color appear when illuminated (types 30 or 40).

AML53 PADDLE SWITCH COVER ORDER GUIDE

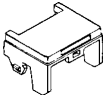
For AML13, AML23, and AML33 incandescent or non-lighted display.

AML53-T	10	R	G																																		
Paddle Switch Cover Type  AML53-E 1/2 Cover  AML53-T Two-Piece Cover	Display/Legend Type Transmitted Color 10 No legend 20 With legend on cap Transmitted Color (Clear cap and color insert) 11 No legend 21 With legend on insert Dead Front (Smoky gray cap and color insert) 30 No legend 40 With legend on insert Projected Color (White cap and color insert) 50 No legend 60 With legend on cap	Cover Color <table border="1" style="width: 100%;"> <thead> <tr> <th style="width: 50%;">1/2 cover, or one side of two-piece cover</th> <th style="width: 50%;">Other side of two-piece cover (see note)</th> </tr> </thead> <tbody> <tr><td>R</td><td>R</td></tr> <tr><td>Red</td><td>Red</td></tr> <tr><td>Y</td><td>Y</td></tr> <tr><td>Yellow</td><td>Yellow</td></tr> <tr><td>G</td><td>G</td></tr> <tr><td>Green</td><td>Green</td></tr> <tr><td>B</td><td>B</td></tr> <tr><td>Blue</td><td>Blue</td></tr> <tr><td>W</td><td>W</td></tr> <tr><td>White</td><td>White</td></tr> <tr><td>K*</td><td>K*</td></tr> <tr><td>Black</td><td>Black</td></tr> <tr><td>L*</td><td>L*</td></tr> <tr><td>Gray</td><td>Gray</td></tr> <tr><td>A**</td><td>A**</td></tr> <tr><td>Amber</td><td>Amber</td></tr> </tbody> </table>		1/2 cover, or one side of two-piece cover	Other side of two-piece cover (see note)	R	R	Red	Red	Y	Y	Yellow	Yellow	G	G	Green	Green	B	B	Blue	Blue	W	W	White	White	K*	K*	Black	Black	L*	L*	Gray	Gray	A**	A**	Amber	Amber
1/2 cover, or one side of two-piece cover	Other side of two-piece cover (see note)																																				
R	R																																				
Red	Red																																				
Y	Y																																				
Yellow	Yellow																																				
G	G																																				
Green	Green																																				
B	B																																				
Blue	Blue																																				
W	W																																				
White	White																																				
K*	K*																																				
Black	Black																																				
L*	L*																																				
Gray	Gray																																				
A**	A**																																				
Amber	Amber																																				

Note: Only one color code letter is necessary when ordering 1/2 covers.

Example: **AML53-T10RG**
Two-piece cover; with transmitted color, no legend; red and green.

* Not for lighted display.
** Not available with projected color.

AML55 PADDLE SWITCH COVER ORDER GUIDE

For AML35 neon display.

AML55-N	10	R	Y
Paddle Switch Cover Type  AML55-N Full Neon Cover, with colored lens	Display/Legend Type Transmitted Color 10 No Legend 20 With Legend	Lens Color T Clear R Red	Cover Color R Red Y Yellow G Green B Blue W White K Black L Gray A Amber

AML55-N covers have a colored lenticular lens window which extends over the neon lamp.

Example: **AML55-N10RY**
Full neon paddle switch cover; with transmitted color, no legend; red lens and yellow cover.



Manual Switches

Covers for Paddle Switches

AML55 PADDLE SWITCH COVER ORDER GUIDE

For AML15 and AML25 LED display.

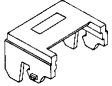
See notes below

AML55-T	10	Y	R	
Paddle Switch Cover Type	Display/Legend Type	Cover Color – See notes below		
AML55-E	Transmitted Color 10 No Legend 20 With Legend	1/2-cover, or LED side of two-piece covers*	Other side of two piece covers	
 1/2 Cover (For one LED)*			R Red Y Yellow G Green B Blue W White K Black L Gray	R Red Y Yellow G Green B Blue W White K Black L Gray
 Two-Piece Cover (For one LED)				
 Two-Piece Cover (For two LED's)				

HOW TO ORDER LEGENDS FOR PADDLE SWITCH COVERS

When specifying legended paddle switch covers, submit a legend order sheet to cover each catalog listing. These forms identify the maximum number of lines per area and the maximum characters per line, based on the type size you request.

To insure proper legend orientation, paddle switch housings (when viewed from the panel front) should have the "MICRO SWITCH" identification facing UP or to the LEFT.

Legend order sheets for covers are shown on the following pages. Reproduce them on your office copier or request a pad of them from the 800 number.:

Legend Sheet	Form No.
AML53 Covers	FO-63567
AML55 Covers	FO-63565

AML55-E, -T, and -H covers have an open window which allows LED's to be flush with the cover surface.

* Notes:

- ¹ Only one color code letter is necessary for AML55-E 1/2 covers.
- ² To order a 1/2-cover without the LED "window," specify an AML53-E listing from the previous page.

Example: **AML55-T10YR**

Two-piece cover; with LED window in one side, transmitted color, no legend; yellow (LED side) and red (non-LED side).

AML Paddle Operator (Cover) Legend Sheet

Account NO 126-251

LEGEND ORDER SLIDE

Button: Type	Figure No	Max Lines/Area				Button Error	Max Characters/Line					
		5/64	7/64	9/64	13/64		5/16	7/64	9/64	13/64	5/16	
E	1	2	1	1	1	0	7	5	5	3	1	0
E	2	2	1	1	1	0	7	5	5	3	1	0
T	3	2	1	1	1	0	7	5	5	3	1	0

Standard Legend Placement - 1. Transmitted Color - Legend on outer shell (Button)
 Use Special Legends Section 2. Dead Front - Legend on insert
 for other placements. 3. Projected Color - Legend on outer shell (Button)
 4. Transmitted color with color with clear cap legend on insert
 5. All legends will be centered within the legendable area

LEGEND ORDER CHART

Customer Part No	Fig No	Type Size	Ink Color		But- ton Qty	Area 1		Area 2	
			5/16	Black		1st Line	2nd Line	1st Line	2nd Line

Catalog Listing
AML53 -
 Customer "O. No. _____ Customer (Dep. No) _____
 MICRO SWITCH Sales Order _____ Line Number _____ Schedule No. _____

Customer: _____
 Address: _____

Instructions
 1. Fill in appropriate catalog listing - or a listing/sheet.
 2. Check proper figure #, Type size, Type color.
 3. Fill in quantity required.
 4. Indicate legends desired - Do not exceed maximums shown in legend order guide.

Note
 1. For Proper Legend Orientation, AML housings (when viewed from front of panel) should have "MICRO SWITCH" logo oriented "UP" on square devices and "UP" or the "LEFT" on rectangular devices.
 2. Please use black ink in filling out this form to help us process your order.

Modified Gothic lettering (A thru Z), numerals (0 thru 9) and Symbols below available in 5/64, 7/64, 9/64, 13/64 and 5/16.		A3 Modified Gothic	
STANDARD SYMBOLS AVAILABLE			
.	;	!	?
'	"	'	"
/	()	*
&			
\$	#	%	o
+	-	±	×
÷	1/3	4/3	2/3
←	→	↔	∞

SPECIAL LEGENDS

NOTE: Use this area to show special Legend locations or Configurations (K-1) shown above. NON-STANDARD legends will involve additional charges and increased delivery time.

Manual Switches

Rocker Switch Operators

AML54/56 Series

COLOR DISPLAY OPTIONS



Rocker operators are assembled to the switches by simply snapping them into recesses in the switch operator sockets.



Transmitted color — Color is displayed whether lamp is On or Off. Choice of 1-piece rockers (types 10 or 20) or rockers with clear cap and colored translucent insert (types 11 or 12).

Dead front hidden color/hidden legend — Rocker appears black with lamp Off. Legend and color appear when illuminated (types 30 or 40).

Projected color — Translucent white rocker with transparent colored insert (types 50 or 60). White rocker appears colored when illuminated.

AML54 ROCKER OPERATOR ORDER GUIDE

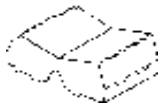
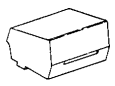
For AML14, AML24, AML34 incandescent or non-lighted display.

<u>AML54-F</u>	<u>10</u>	<u>R</u>	
Rocker Operator Type	Display/Legend Type	Rocker Color – See Note Below	
AML54-F	Transmitted Color	Full rocker, 1/2 rocker, or one side of two-piece rockers	Other side of two-piece rockers
 Full Rocker	10 No legend 20 With legend on cap	R Red Y Yellow G Green B Blue W White K* Black L* Gray A** Amber	R Red Y Yellow G Green B Blue W White K* Black L* Gray A** Amber
 1/2 Rocker	Transmitted Color (Clear cap and color insert) † 11 No legend 21 With legend on insert		
 Two-Piece Rocker	Dead Front † (Smoky gray cap and color insert) 30 No legend 40 With legend on insert		
	Projected Color † (White cap and color insert) 50 No legend 60 With legend on cap		

NOTE: AML54-F10 and AML54-F20 are one-piece, one-color full rockers. Thus only one color code letter is necessary when ordering. Include a two letter code for all other AML54-E (and AML54-T) catalog listings.

* Not for lighted display.
 ** Not available with projected color or dead front.
 † Not available for use with AML34 power switches.

Example: **AML54-F10R**
 Full rocker; with transmitted color, no legend; red.

AML56 ROCKER OPERATOR ORDER GUIDE

For AML36 neon display.

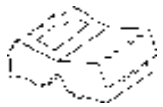
<u>AML56-N</u>	<u>10</u>	<u>R</u>	<u>Y</u>
Rocker Operator Type	Display/Legend Type	Lens Color	Rocker Color
AML56-N  Full Rocker with Colored Lens	Transmitted Color 10 No Legend 20 With Legend	T Clear R Red Y Yellow	R Red Y Yellow G Green B Blue W White K Black

AML56-N rockers have a colored lenticular lens window which extends over the neon lamp.



Example: **AML56-N10RY**
 Full rocker; with transmitted color, no legend; yellow rocker and red lens.

Manual Switches

Rocker Switch Operators

AML56 ORDER GUIDE

For AML16 and AML26 LED display.

AML56-T	10	R	B
Rocker Operator Type	Display/Legend Type	Rocker Color – See Notes Below	
AML56-E	Transmitted Color 10 No Legend 20 With Legend	1/2-rocker or LED side of two-piece rockers	Other side of two piece rockers
 1/2-Rocker* (For one LED)		R Red Y Yellow G Green B Blue W White K Black L Gray	R Red Y Yellow G Green B Blue W White K Black L Gray
AML56-T  Two-Piece Rocker (For one LED)			
AML56-H  Two-Piece Rocker (For two LED's)			

HOW TO ORDER ROCKER LEGENDS

When specifying legended rockers, submit a legend order sheet to cover each catalog listing. These forms identify the maximum number of lines per area and the maximum characters per line, based on the type size you request. To insure proper legend orientation, rocker switch housings (when viewed from the panel front) should have the "MICRO SWITCH" identification facing UP or to the LEFT.

Rocker legend order sheets are shown on the following pages. Reproduce them on your office copier.





Legend Sheet	Form No.
AML54 Rockers	FO-63566
AML56 Rockers	FO-63564

Example: **AML56-T10RB**
 Two-piece rocker; with LED window in one side, transmitted color, no legend; red (LED side) and blue (non-LED side).

- * Notes:
- ¹ Only one color code letter is necessary for AML56-E 1/2-rockers. AML56-E, -T, and -H rockers have an open window which allows LEDs to be flush with the rocker surface.
 - ² To order a 1/2-rocker without the LED "window," specify an AML54-E listing from the previous page.

AML Rocker Legend Sheet

Account NO 126-284

Legend Order Guide										
Button Type Orientation	Figure No		Max Lines/Area		Max Characters/Line					
	5/64	7/64	9/64	13/64	5/16	5/64	7/64	9/64	13/64	5/16
 AREA 1	1	2	2	1	1	7	5	4	3	1
 AREA 1	2	2	2	1	1	7	5	4	3	1
 AREA 1	3	2	2	2	1	7	5	4	3	1
 AREA 2	4	2	2	2	1	7	5	4	3	1

Standard Legend Placement — 1. Transmitted Color—Legend on outer shell (Button)
 2. Dead Front—Legend on insert
 3. Projected Color — Legend on outer shell (Button)
 4. Transmitted color with clear cap legend on insert.
 5. All legends will be centered within the legendable areas.

LEGEND ORDER CHART

Customer Part No	Fig No	Type Size		Ink Color		But- ton Qty	Area 1 Sequence: Left-to-Right or Top-to-Bottom		Area 2
		5/64	7/64	9/64	13/64		5/16	1st Line	

Customer Library
AML54 —
Customer P.O. No. _____ Customer Dept. No. _____
MICRO SWITCH Sales Order _____
Order Number _____
Schedule No. _____
Customer: _____
Address: _____
12/76 19591

Instructions
 1. Fill in appropriate catalog listing — one listing sheet.
 2. Check proper figure #, Type size, Type color.
 3. Fill in quantity required.
 4. Indicate legends desired — Do not exceed maximums shown in legend order guide.

Note

1. For Proper Legend Orientation, AML housings (when viewed from front of panel) should have "MICRO SWITCH" logo oriented "UP" on square devices and "UP" or to the "LEFT" on rectangular devices.
 2. Please use black ink in filling out this form to help us process your order.

SPECIAL LEGENDS

NOTE: Use this area to show special Legend Locations or Oval Graphics. Insert a note below, indicating (UP/DOWN) legends and remove optional charges and increased delivery time.

Fig. 'A' _____ Fig. 'B' _____

Modified Gothic lettering (A thru Z), numerals (0 thru 9), and Symbols below available in 5/64, 7/64, 9/64, 13/64, and 5/16.	A3 Modified Gothic
--	------------------------------

STANDARD SYMBOLS AVAILABLE

•	!	?	'	—	"	/	()	+	&
\$	¢	%	°	+	-	±	×	÷	<
→	↑	↓	←	↖	↗	↘	↙	↕	∞

Honeywell

AML Rocker Legend Sheet

Account NO 126-2B4

Legend Order Guide																				
Button Type Orientation	Figure No	Max Lines/Area			Max Characters/Line			AREA	1	2										
		5/64	7/64	9/64	13/64	5/16	7/64				9/64	13/64	5/16							
1	E	1	1	1	0	0	5/16	7/64	9/64	13/64	5/16	7	5	5	3	0	0			
1	E	2	1	1	1	0	0	0	0	0	0	7	5	5	3	0	0			
1	H	3	1	1	1	0	0	0	0	0	0	7	5	5	3	0	0			
2	N	4	2	2	2	1	1	1	1	1	1	7	6	5	3	1				
2	T	5	1	2	1	1	1	0	1	1	1	7	6	5	3	0	1			

Standard Legend Placement — 1. All legends will be centered within the legible areas.
Use Special Legends Section for other placements.

Customer Name: _____
AML56 — Customer Dept. No. _____
 MICRO SWITCH Sales Order _____
 Line Number _____
 Special No. _____

Customer: _____
 Address: _____
 (city) _____
 (state) _____

- Instructions**
1. Fill in appropriate catalog listing - one listing/sheet.
 2. Check proper figure #, Type size, Type color.
 3. Fill in quantity required.
 4. Indicate legends desired — Do not exceed maximums shown in legend order guide.

Note

1. For Proper Legend Orientation, AML housings (when viewed from front of panel) should have "MICRO SWITCH" logo oriented "UP" on square devices and "UP" or "to the LEFT" on rectangular devices.
2. Please use black ink in filling out this form to help us process your order.

SPECIAL LEGENDS

NOTE: Use this area to show special Legend Layouts or Colorings. Items NOT shown below. NON-STANDARD legends will receive additional charges at increased factory price.

Fig. "A"

Fig. "B"

Modified Gothic lettering (A thru Z), numerals (0 thru 9) and Symbols below available in 5/64, 7/64, 9/64, 13/64 and 5/16.

A3 Modified Gothic

STANDARD SYMBOLS AVAILABLE

·	:	;	!	?	'	—	"	/	()	*	&
\$	¢	#	%	o	+	-	±	÷	x	=	>
→	↑	↓	←	↻	1/4	1/2	3/4	1/3	2/3	∞	

LEGEND ORDER CHART

Customer Part No	Fig No	Type Size	Ink Color	Area 1		Area 2															
				1st Line	2nd Line	1st Line	2nd Line														
		5/64	7/64	9/64	13/64	5/16	Black	White	Blank	Blank	Blank	Blank	Blank	Blank	Blank	Blank	Blank	Blank	Blank	Blank	

PO-0004-D _____ (Date)
 _____ (Signature)

Manuals

Manual Switches

Mounting Hardware

AML61 Series

FOR STRIP AND MATRIX MOUNT ASSEMBLIES











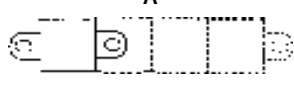
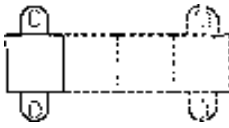

FEATURES

- Enables subpanel mounting of devices in factory assembled metal cans which are welded together in strips or matrices. Assures accurate alignment and enables pre-wiring.
- L-shaped mounting brackets conform to various panel thicknesses, using spacers.
- Simplifies panel fabrication, since only one large cutout is required.
- Facilitates printed circuit board mounting. Operating force is transmitted to mounting hardware, rather than P.C. board.
- For custom matrices contact the MICRO SWITCH Application Center.
- Mounting dimensions page 65.

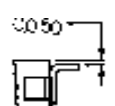
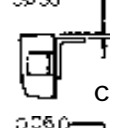
AML61 MOUNTING HARDWARE ORDER GUIDE

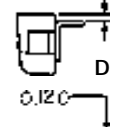
(For standard strip mount assemblies)

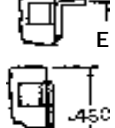
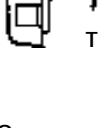
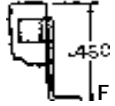
AML61 B	A	5	A
Type	Mounting Bracket Orientation	Number of Cans	Mounting Bracket Location
Square cans: AML61 B (Plain finish) AML61 J (Black finish)	<p style="text-align: center;">A</p>  <p style="text-align: center;">E</p> 	1 2 3 4 5 6 7 8 9* 10* 11* 12*	 <p style="text-align: center;">BRACKET FLUSH TO TOP OF CAN</p>  
Rect. cans: AML61 E (Plain finish) AML61 K (Black finish)	<p style="text-align: center;">B</p>  <p style="text-align: center;">C</p>  <p style="text-align: center;">D</p> 	<p style="text-align: center;">*A, C, D & E orientation only.</p>	       <p style="text-align: center;">U NO BRACKETS</p>

① To order one rectangular can with mounting brackets on short sides, specify AML61EB1____ or AML61KB1____.

Example: **AML61EC5A**
 Five rectangular cans, plain finish (unpainted), long sides abutting; type **A** mounting brackets on long sides, located flush with switch or indicator bezel. (Type **T** bracket brings top of annunciator bezel flush with top of .160 in./4,1 mm panel.)

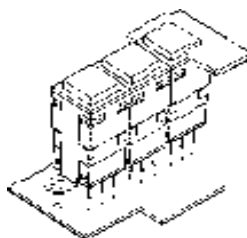

This strip has Type F brackets for P.C. board mounting.

NON-STANDARD ASSEMBLIES

Use the order form on the following page to specify non-standard AML61 strip or matrix assemblies. You may reproduce it on your office copier, or order pads from the 800 number. Request FO-63558.

Manual Switches

Barriers/Panel Seal Accessories

AML71 BARRIERS

When mounting an individual unit, an end barrier is attached to each side of the housing. The center barrier is used in a slot mount array.

FEATURES

- Barriers separate individually mounted switches and indicators — help prevent inadvertent actuation of two pushbutton switches with a single push.
- Front of panel mounting simplifies installation.

AML71 BARRIER ORDER GUIDE (See notes)

Barriers shown in order guide are black.

Barrier Length	Type	Catalog Listing
Short (For use with square devices and short side of rectangular devices.)	Center	AML71SCB
	End	AML71SEB
Long (For use with long side of rectangular devices.)	Center	AML71LCB
	End	AML71LEB

Notes:

Not for use with AML61 mounting hardware or any full guard bezel products.
Not for use with AML41J, K, or L lens type indicators; or AML45 annunciators.

FEATURES

- AML75 panel seals fit pushbutton switches and indicators.
- Provides protection from contamination from accidental beverage spills, dust, and dirt.
- Easy to install, without tools
- No effect on display color, light intensity, or legend quality.
- Replace seal or change lamps without removing switch from panel.
- For .19-inch standard height square or rectangular pushbuttons.
- Mounting dimensions page 66.

The design complements AML's functional appearance, creating a pleasing framed effect around the button. It consists of a matte black plastic base which press-fits between the panel and switch bezel, and a transparent flexible seal which snaps into the base. PK 8521, shipped with each order, provides installation instructions.

Button colors and legends can be viewed without distortion whether lighted or unlighted. Seals can be conveniently replaced or removed for relamping, without removing the switch from panel.

Operating temperature range is 32° to 131°F (0° to 55°C).

AML75 PANEL SEAL ORDER GUIDE

Description	For Use With:		
	Square .19" high pushbuttons	Rectangular .19" high pushbuttons	Rockers
Base & Seal	AML75ABC	AML75BBC	AML75RBC
Base Only	AML75ABN	AML75BBN	—
Seal Only	AML75ANC	AML75BNC	—

Notes:

Multiple units should not be mounted in a single slot, since this would create an unsealed space between each unit. AML75 seals are not for use with barriers, full

guard bezels, AML61 mounting hardware, AML45 annunciators, or AML41J, K, or L lens type indicators.

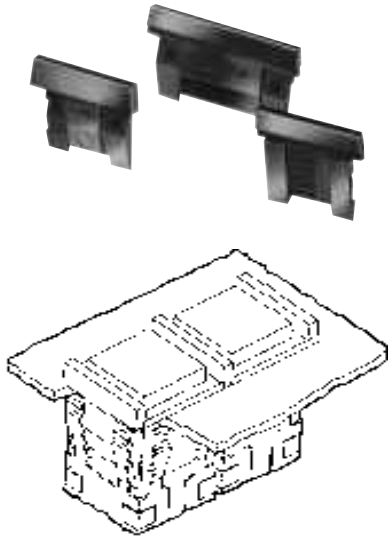

Drawing shows two switches, slot mounted. From left to right: one center barrier, a second switch, plus another end barrier to complete the arrangement.

AML75 PANEL SEAL



MATERIAL
Base: Polypropylene
Cap: Polyvinyl Chloride

Manual Switches

Switch Guard/Panel Plugs, Dummy Housings

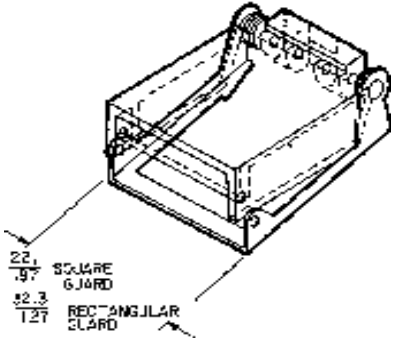

FEATURES

- Button cannot be operated when switch guard cover is closed, preventing accidental operation
- Wire lock-down feature further prevents unintentional actuation of the switch.
- Lamps can be replaced with the switch guard attached, without special tools, saving maintenance time
- Can be used with alternate or momentary action square or rectangular .19 inch standard height AML buttons
- Shock resistant construction, for long, maintenance-free life

AML76 switch guard protects square and rectangular .19-inch standard height pushbuttons from inadvertent actuation. It is for use with standard bezel type switches only.

See page 66 for mounting dimensions.

The switch guard cover is clear, polycarbonate thermoplastic through which the button is easily visible. The word "lift" is molded onto the top front edge of the guard. The bracket is bright-finished stainless steel.

The switch guard may be assembled to the AML pushbutton before the switch is installed in a panel. Or, the guard can be assembled to a pushbutton already mounted in a panel, providing the wiring is sufficiently slack to raise the switch bezel above the panel; and if there is sufficient clearance with adjacent units. PK 8522 contains installation instructions and is shipped with each order.

AML switch guards may be mounted in horizontal or vertical matrices. A wire lock-down feature, using .020-inch diameter locking wire, may be used as an additional protection.

SWITCH GUARD ORDER GUIDE

Guard Type*	Catalog Listing
Square	AML76C10T01P
Rectangular	AML76F10T01P

* The word "LIFT" is molded into the cover. If other languages are desired contact the 800 number.
 Note: Switch guard is not designed for use with AML61 mounting hardware, AML71 barriers, or full guard bezel switches.

CONNECTOR BLOCK



This connector block can be used with square 1 and 2 pole AML21 switches with .110 x .020 terminals to enable plug-in wiring.

AML78 PANEL PLUGS

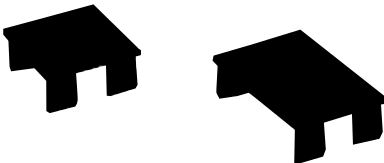

Plastic panel plugs (shown above) enable the user to provide for future needs by punching extra panel holes. Finished in matte black, they are the same height as the standard AML bezel when snapped in place from the panel front.

Panel plugs are only for use in individual holes or with AML61 mounting hardware in multi-station strips. (Use dummy housings in strip cutouts without AML61 mounting hardware.)

PANEL PLUG ORDER GUIDE

Plug Type	Catalog Listing
Square	AML78CB
Rectangular	AML78FB

AML78 DUMMY HOUSINGS

Dummy housings can be used to provide for expansion needs in strip cutouts without AML61 mounting hardware. They have mounting clips, but there is no provision for switching or illumination.

DUMMY HOUSING ORDER GUIDE

Dummy Housing Type*	Catalog Listing
Square (Pushbutton style)	AML78C100
Rectangular (Pushbutton style)	AML78F100
Rectangular (Lens indicator style)	AML78J100

* Order AML51 Buttons/lenses for use with dummy housings.

Manual Switches

Lamps, Soldering Recommendations, Receptacles

AML91 LAMP ORDER GUIDE

Lamp Type	Industry Lamp No.	Voltage	Catalog Listing
Incandescent T-1-3/4 wedge base	86	6.3	AML91LA86
	73	14.0	AML91LA73
	85	28.0	AML91LA85

LAMP DATA

The following data was compiled from manufacturer's specifications, for reference only.

INCANDESCENT LAMPS

Industry Lamp No.	Volts	Amps	Watts	MSCP	Life A/C Volts
86	6.3	.200	1.25	.49	20,000 hours
	5.5	.185	1.12	.246	106,200 hours
	5.0	.177	.89	.185	290,000 hours
73	14.0	.080	1.12	.30	15,000 hours
	12.0	.077	1.00	.23	36,450 hours
85	28.0	.04	1.12	.30	7,000 hours
	24.0	.037	.89	.177	41,860 hours

Neon Lamps

25,000 hours (half life)

INTEGRAL LEDs

LEDs Furnished Permanently Installed in These Products	V _f	I _f	V _{PD}	Peak Inverse Voltage	
				w/o Diode Protection	w/Diode Protection
AML12, 15, 16, 22, 25, 26, 42	2.4 V	20 mA	.7 V	5 V	34 V
AML45	2.4 V	20 mA	.7 V	4 V	33 V

100,000 hours (half life).

AML92 SERIES LEDs



For use with these AML switches and indicators equipped with lamp sockets:

Pushbutton switches: AML11 (Square Only)*, AML21 (rectangular and square), and AML31.

Paddle switches: AML31/23/33

Rocker switches: AML14/24/34

Indicators: AML41

* Rectangular solid state with one or two lamp circuits cannot be used with LED catalog listings ending in "L".

AML92 ORDER GUIDE

LED Color	Quad Chip	Six Chip
Red	AML92ERY	AML92ERL
Green	AML92EGY	AML92EGL
Yellow	AML92EYY	AML92EYL
White	—	AML92EWL*

* For use with white or yellow buttons.

OPERATING CHARACTERISTICS

Type	V _f Fwd. Voltage (typ.)				I _f Fwd. Current	V _R Rev. Voltage
	Yellow	Green	Red	White		
Quad Chip	8.6	8.6	7.8	—	15 mA	16 V
Six Chip	4 V	4 V	4 V	4 V	50 mA	5.6 V

TEMPERATURE RANGE

(Quad Chip or Six Chip)

Operating: -20 to 60°C (-4 to 140°F)

Storage: -30 to 100°C (-22 to 212°F)

SOLDERING RECOMMENDATIONS

All terminals are solder plated. Proper soldering and cleaning procedures must be followed to maintain the reliability of AML products during installation. An instruction sheet which outlines these procedures is included with AML shipments. You may also obtain a copy from your MICRO SWITCH Sales Office. Request PK 8518.

As a general guide, the following information may be used:

Use a 280°C (538°F) solder iron tip, up to 6 seconds duration, with a 60-40 rosin core solder. This allows the terminal to heat quickly on the exterior of the housing only, and greatly reduces the chance of flux migrating inside the housing.

LED APPLICATION INFORMATION

For those devices without internal current limiting resistors, suitable external control of the LED current must be provided. It is recommended that a minimum of 5 VDC open circuit voltage with an appropriate series resistance be used to drive LED devices. This minimizes the effect of temperature (current variation) on forward voltage of the LED.

Resistor values can be determined by supply voltage or current for LED:

$$R_s = \frac{E - V_f}{I_f}$$

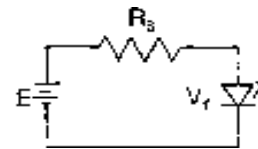

WHERE: R_s = Series Resistance
E = Supply Voltage
V_f = Forward Voltage of LED
I_f = Circuit Current

If a diode is added in series for reverse polarity protection then:

$$R_s = \frac{E - V_f - V_{PD}}{I_f}$$

WHERE: V_{PD} Forward Voltage of Protection Diode