

HIH-4602-A/C Series

Humidity Sensors

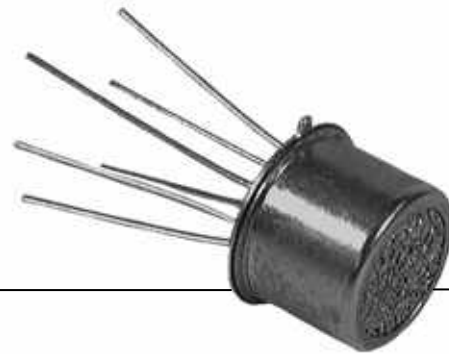

DESCRIPTION

HIH-4602-A/C Series Relative Humidity (RH) sensors combine both relative humidity and temperature sensing in a TO-5 housing with a hydrophobic sintered stainless steel filter.

The laser-trimmed, thermoset polymer capacitive sensing elements have on-chip integrated signal conditioning.

The temperature sensor is thermally connected with the RH sensor making the HIH-4602-A/C often ideal for measuring dew point and other absolute moisture terms.

FEATURES

- Near linear voltage output vs %RH
- Laser-trimmed interchangeability
- Enhanced accuracy, fast response
- Chemically resistant
- Stable, low drift performance
- Built-in static protection
- Often ideal for dew point and absolute moisture measurements
- TO-5 housing

The HIH-4602-A contains an integral thermistor, while the HIH-4602-C contains an integral precision RTD.

Factory calibration data supplied with each sensor allows individually matched downstream electronics and ± 3.5 %RH total accuracy.

POTENTIAL APPLICATIONS

- Refrigeration
- Drying
- Meteorology
- Battery-powered systems
- OEM (Original Equipment Manufacturer) assemblies

HIH-4602-A/C Series

TABLE 1. PERFORMANCE SPECIFICATIONS (At 5 Vdc supply and 25 °C [77 °F] unless otherwise noted.)

Parameter	Minimum	Typical	Maximum	Unit	Specific Note
Interchangeability (first order curve)	–	–	–	–	–
0% RH to 59% RH	-5	–	5	% RH	–
60% RH to 100% RH	-8	–	8	% RH	–
Accuracy (best fit straight line)	-3.5	–	+3.5	% RH	1
Hysteresis	–	3	–	% RH	–
Repeatability	–	±0.5	–	% RH	–
Settling time	–	–	70	ms	–
Response time (1/e in slow moving air)	–	50	–	s	–
Stability (at 50% RH in one year)	–	±1.2	–	% RH	–
Voltage supply	4	–	5.8	Vdc	–
Current supply	–	200	500	µA	–
Output voltage temp. coefficient at 50% RH, 5 V	–	-4	–	mV/°C	–
Voltage output (1st order curve fit)	$V_{OUT} = (V_{SUPPLY})(0.0062(\text{sensor RH}) + 0.16)$, typical at 25 °C				
Temperature compensation	True RH = (sensor RH)/(1.0546-0.00216T), T in °C				
Operating temperature	-40[-40]	See Figure 1.	85[185]	°C[°F]	–
Operating humidity	0	See Figure 1.	100	% RH	2
Storage temperature	-50[-58]	–	125[257]	°C[°F]	–
Storage humidity	See Figure 2.			% RH	2

Specific Notes:

1. Device is calibrated at 5 Vdc and 25 °C.
2. Non-condensing environment.

General Notes:

- Sensor is ratiometric to supply voltage.
- Extended exposure to ≥90% RH causes a reversible shift of 3% RH.
- Sensor is light sensitive. For best performance, shield sensor from bright light.

FACTORY CALIBRATION DATA

HIH-4602 Sensors are supplied with a calibration and data printout. See Table 2.

TABLE 2. EXAMPLE DATA PRINTOUT

Model	HIH-4602-C
Channel	92
Wafer	030996M
MRP	337313
Calculated values at 5 V	
V _{OUT} at 0% RH	0.826 V
V _{OUT} at 75.3% RH	3.198 V
Linear output for 3.5% RH accuracy at 25 °C	
Zero offset	0.826 V
Slope	31.483 mV/%RH
RH	(V _{OUT} - zero offset)/slope (V _{OUT} - 0.826)/0.0315
Ratiometric response for 0% RH to 100% RH	
V _{OUT}	V _{SUPPLY} (0.1652 to 0.7952)

TABLE 3. HIH-4602-A NTC THERMISTOR TEMPERATURE SPECIFICATIONS

R _b = 100 kOhm ±5% at 25 °C		
Beta = 4250, 25 °C to 85 °C		
1/T = a + b(Ln R) + c(Ln R) ^ 3, T in degrees K		
	Temp. °C	Resistance
Low	0	351000
Mid	50	33590
High	100	5569
a = 0.000828083		
b = 0.000208691		
c = 8.0812E-08		

TABLE 4. HIH-4602-C RTD TEMPERATURE SENSOR SPECIFICATIONS

Thin film platinum RTD – Class 2B (R ₀ : ±0.25%)
DIN EN 60571 (PER IEC 751)
TCR = 3750 ppm/°C
1000 Ohm at 0 °C [32 °F]



Humidity Sensors

FIGURE 1. OPERATING ENVIRONMENT (Non-condensing environment.)

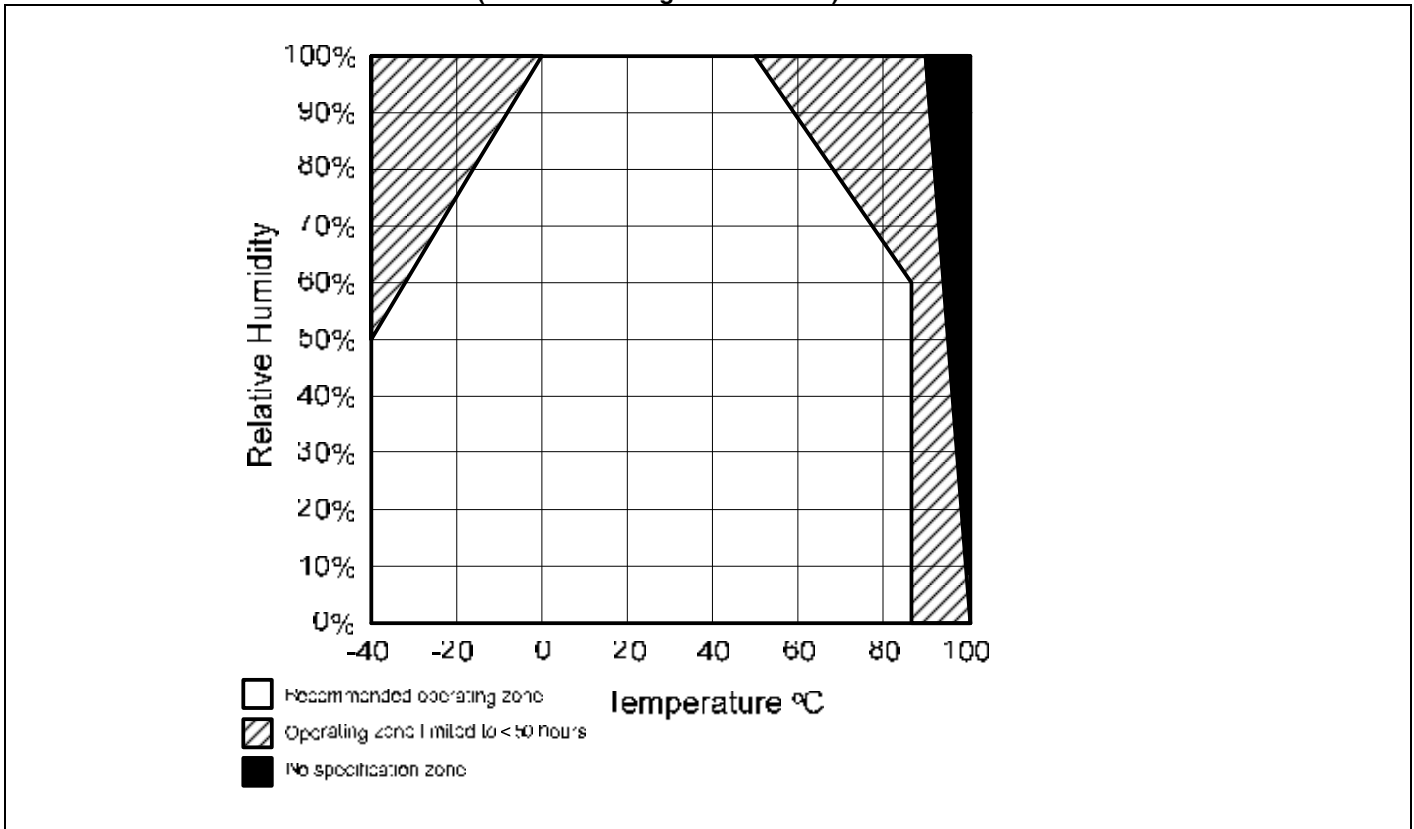
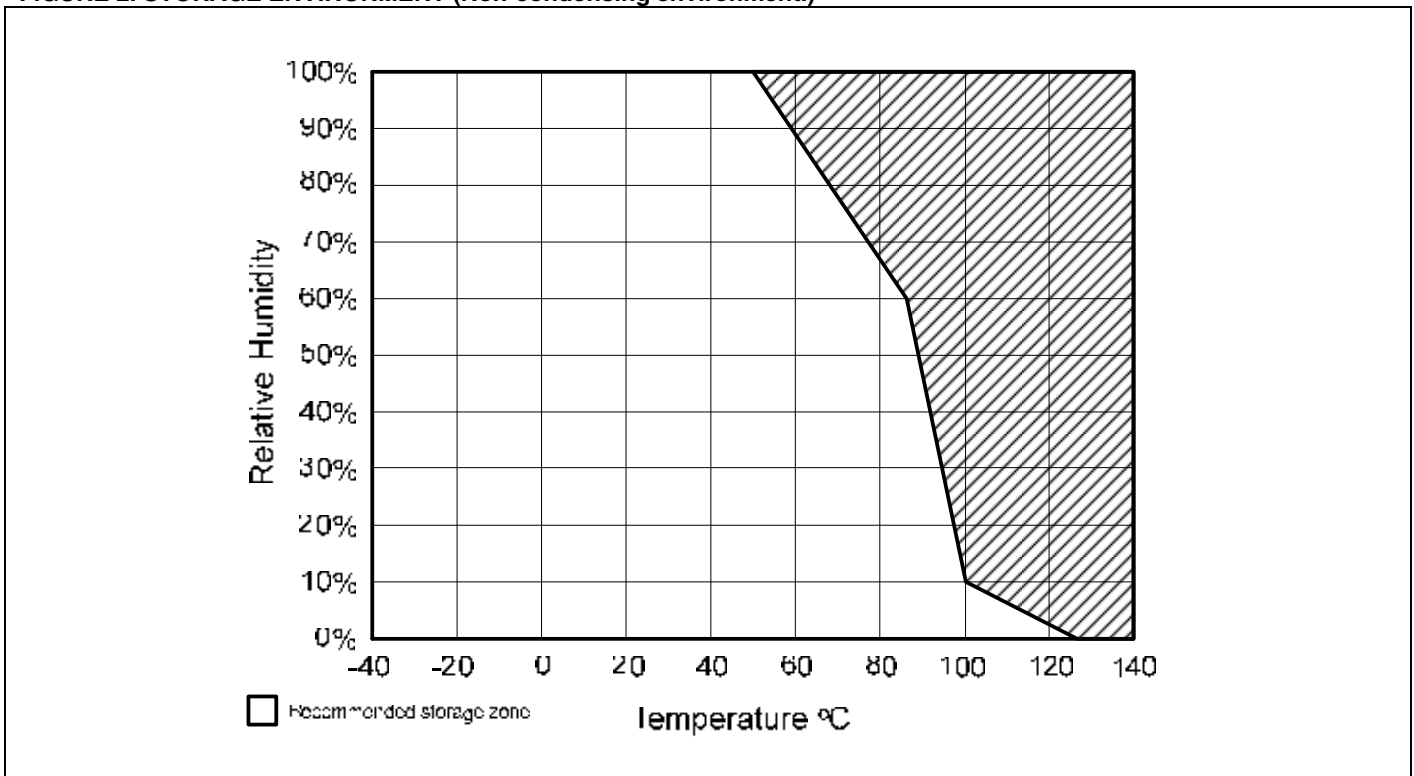

FIGURE 2. STORAGE ENVIRONMENT (Non-condensing environment.)



HIH-4602-A/C Series

FIGURE 3. TYPICAL OUTPUT VOLTAGE VS RELATIVE HUMIDITY (At 25 °C and 5 V.)

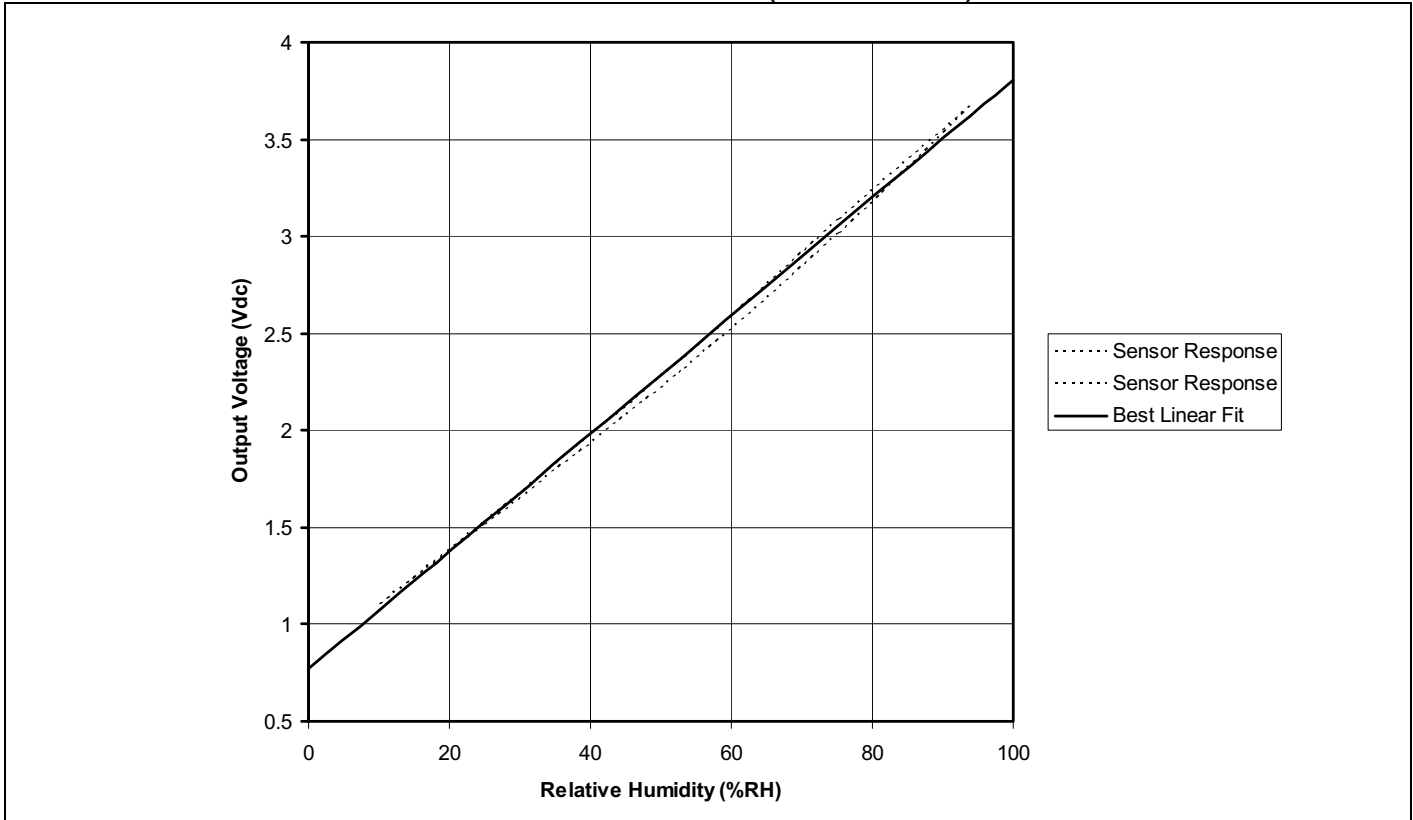
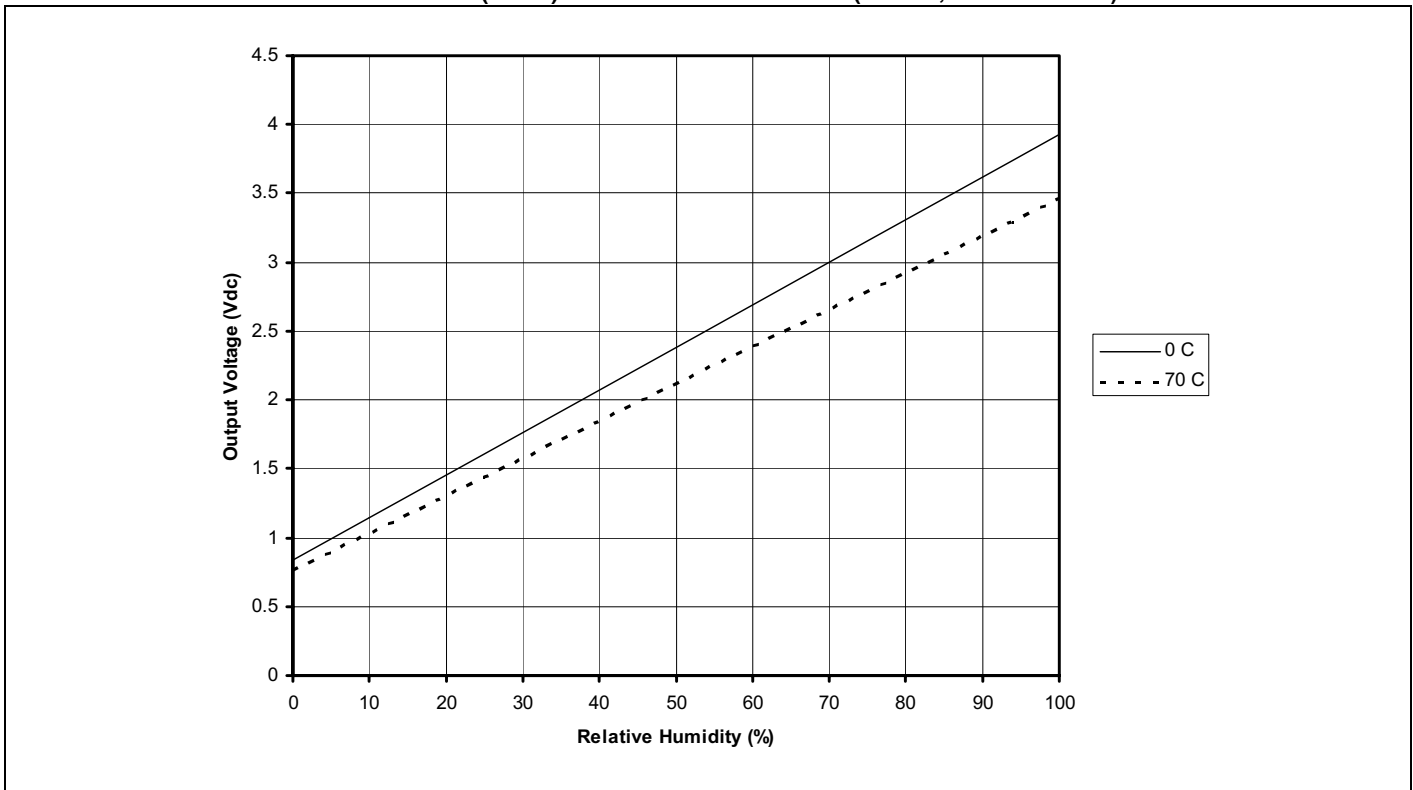

FIGURE 4. TYPICAL OUTPUT VOLTAGE (BFSL) VS RELATIVE HUMIDITY (At 0 °C, 70 °C and 5 V.)



Humidity Sensors

FIGURE 5. HIH-4602-A/C 1 MOUNTING DIMENSIONS (For reference only. mm/[in])

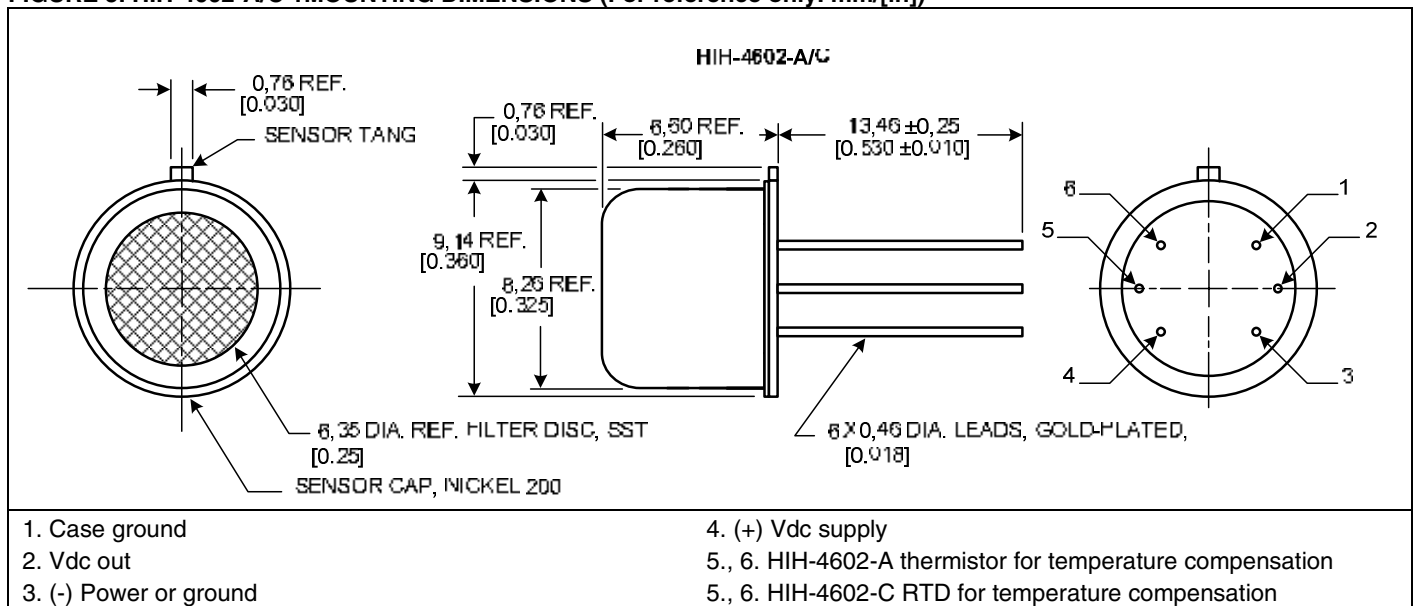
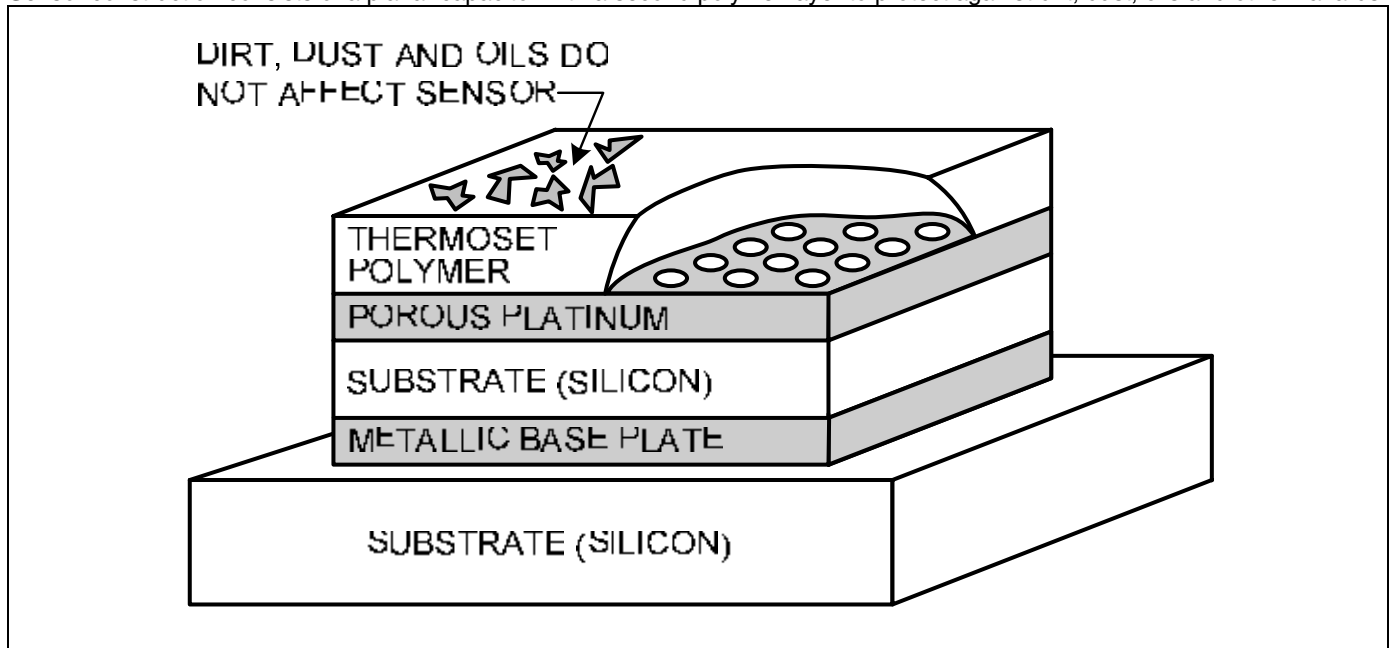

FIGURE 6. RH SENSOR CONSTRUCTION

Sensor construction consists of a planar capacitor with a second polymer layer to protect against dirt, dust, oils and other hazards.



HIH-4602-A/C Series

FIGURE 7. TYPICAL APPLICATION CIRCUIT

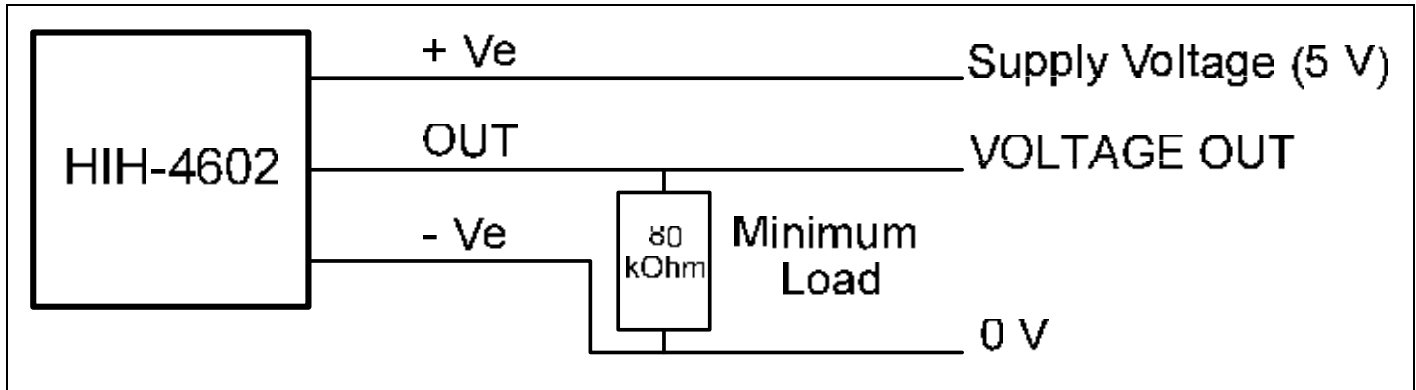

ORDER GUIDE

Catalog Listing	Description
HIH-4602-A	Monolithic IC humidity sensor with integral thermistor in TO-5 can
HIH-4602-C	Monolithic IC humidity sensor with integral precision RTD in TO-5 can

FURTHER HUMIDITY SENSOR INFORMATION

See the following associated literature at www.honeywell.com/sensing:

- Product installation instructions
- Application sheets:
 - Humidity Sensor Performance Characteristics
 - Humidity Sensor Theory and Behavior
 - Humidity Sensor Moisture and Psychrometrics
 - Thermoset Polymer-based Capacitive Sensors

Humidity Sensors

THIS PAGE INTENTIONALLY LEFT BLANK..

WARNING

MISUSE OF DOCUMENTATION

- The information presented in this product sheet is for reference only. Do not use this document as a product installation guide.
- Complete installation, operation, and maintenance information is provided in the instructions supplied with each product.

Failure to comply with these instructions could result in death or serious injury.

WARRANTY/REMEDY

Honeywell warrants goods of its manufacture as being free of defective materials and faulty workmanship. Honeywell's standard product warranty applies unless agreed to otherwise by Honeywell in writing; please refer to your order acknowledgement or consult your local sales office for specific warranty details. If warranted goods are returned to Honeywell during the period of coverage, Honeywell will repair or replace, at its option, without charge those items it finds defective. **The foregoing is buyer's sole remedy and is in lieu of all other warranties, expressed or implied, including those of merchantability and fitness for a particular purpose. In no event shall Honeywell be liable for consequential, special, or indirect damages.**

While we provide application assistance personally, through our literature and the Honeywell web site, it is up to the customer to determine the suitability of the product in the application.

Specifications may change without notice. The information we supply is believed to be accurate and reliable as of this printing. However, we assume no responsibility for its use.

WARNING

PERSONAL INJURY

DO NOT USE these products as safety or emergency stop devices or in any other application where failure of the product could result in personal injury.

Failure to comply with these instructions could result in death or serious injury.

SALES AND SERVICE

Honeywell serves its customers through a worldwide network of sales offices, representatives and distributors. For application assistance, current specifications, pricing or name of the nearest Authorized Distributor, contact your local sales office or:

E-mail: info.sc@honeywell.com

Internet: www.honeywell.com/sensing

Phone and Fax:

Asia Pacific	+65 6355-2828 +65 6445-3033 Fax
Europe	+44 (0) 1698 481481 +44 (0) 1698 481676 Fax
Latin America	+1-305-805-8188 +1-305-883-8257 Fax
USA/Canada	+1-800-537-6945 +1-815-235-6847 +1-815-235-6545 Fax

Automation and Control Solutions

Sensing and Control

Honeywell

1985 Douglas Drive North

Minneapolis, MN 55422

www.honeywell.com/sensing

009022-1-EN IL50 GLO Printed in USA
January 2007

© 2007 Honeywell International Inc. All rights reserved.

Honeywell