

Magnetic Position Sensors Low-Cost, Bipolar, Hall-effect Sensors

SS40A/SS50AT Series

FEATURES

- Small size
- Low cost
- Reverse polarity protection
- Sensitive - bipolar magnetics respond to alternating north and south poles
- Thermally balanced, integrated circuit over a full temperature range
- Stable operation

TYPICAL APPLICATIONS

- Cooling fan control in computers and appliances
- RPM (revolutions per minute) sensing, speed control
- Brushless dc motor commutation
- Position sensing and motor control
- Simple magnetic encoder
- Flow-rate sensor



The SS40A/SS50AT Series sensors are low-cost, bipolar, Hall-effect sensors. These sensitive magnetic sensors offer reverse polarity protection and deliver stable output over a -40 °C to 125 °C [-40 °F to 257 °F] temperature range. Operation from any dc supply voltage from 4.5 Vdc to 24.0 Vdc is acceptable.

The SS40A/SS50AT Series sensors build upon Honeywell's popular magnetic position sensors and offer several competitive advantages. These sensors have been designed with the latest technologies to provide reliable, cost-effective solutions to commercial, computer, medical, and/or consumer applications requiring motor control and RPM sensing.

These products are available in a variety of package styles to suit a number of applications. Ammopack versions, along with tape-and-reel, are standard. The surface mount version is mounted directly on the electrical traces on a PC (printed circuit) board. It is attached by an automatic solder reflow operation which requires no hole, so it reduces the cost of the PC board.

WARNING

PERSONAL INJURY

DO NOT USE these products as safety or emergency stop devices or in any other application where failure of the product could result in personal injury.

Failure to comply with these instructions could result in death or serious injury.



WARNING

MISUSE OF DOCUMENTATION

- The information presented in this product sheet is for reference only. Do not use this document as a product installation guide.
- Complete installation, operation, and maintenance information is provided in the instructions supplied with each product.

Failure to comply with these instructions could result in death or serious injury.

Magnetic Position Sensors

Low-Cost, Bipolar, Hall-effect Sensors

SS40A/SS50AT Series

ABSOLUTE MAXIMUM RATINGS*

Parameter	Min.	Typ.	Max.	Unit
Supply voltage	-28	-	28	V
Applied output voltage	-0.5	-	28	V
Output current	-	-	20	mA
Magnetic flux	-	-	No limit	Gauss

*Absolute maximum ratings are the extreme limits the device will withstand without damage to the device. However, the electrical and mechanical characteristics are not guaranteed as the maximum limits (above recommended operating conditions) are approached, nor will the device necessarily operate at absolute maximum ratings.

ELECTRICAL CHARACTERISTICS

At $V_s = 4.5\text{ V}$ to 24 V with 20 mA load with $T_a = -40\text{ }^\circ\text{C}$ to $125\text{ }^\circ\text{C}$ [$-40\text{ }^\circ\text{F}$ to $257\text{ }^\circ\text{F}$] unless otherwise noted.

Parameter	Cond.	Min.	Typ.	Max.	Unit
Supply voltage	-	4.5	-	24.0	V
Supply current	25 °C [77 °F]	-	6.8	10.0	mA
Supply current	-	-	-	11.3	mA
Output current	-	-	-	20.0	mA
Vsat @ 15 mA	Gauss >170	-	-	0.4	V
Output leakage	Gauss <-170	-	-	10.0	μA
Rise time	25 °C [77 °F]	-	0.5	1.5	μs
Fall time	25 °C [77 °F]	-	0.2	1.5	μs
Response time	25 °C [77 °F]	-	4.0	5.0	μs
Operate	25 °C [77 °F]	-	45	110	Gauss
Operate	0 °C to 85 °C [32 °F to 185 °F]	-	50	130	Gauss
Operate	-	-	55	170	Gauss
Release	25 °C [77 °F]	-110	-45	-	Gauss
Release	-40 °C to 85 °C [-40 °F to 185 °F]	-130	-50	-	Gauss
Release	-	-170	-55	-	Gauss
Differential	-	50	-	-	Gauss
Operating temperature	-40 °C to 125 °C [-40 °F to 257 °F]				
Storage temperature	-55 °C to 165 °C [-67 °F to 329 °F]				

SS40A SERIES MOUNTING DIMENSIONS (for reference only) mm/[in]

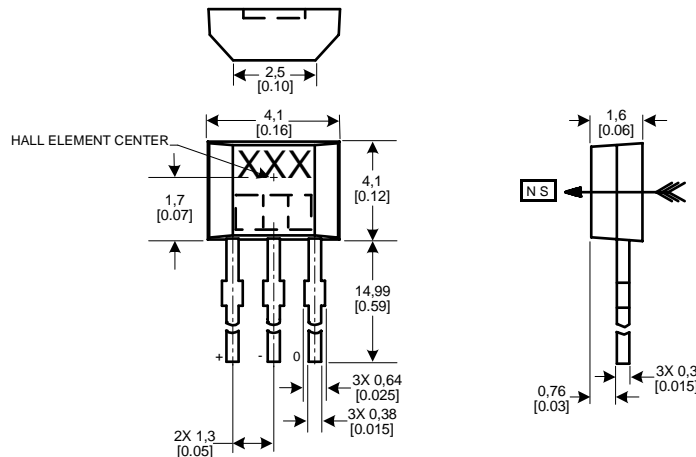

Magnetic Position Sensors

Low-Cost, Bipolar, Hall-effect Sensors

SS40A/SS50AT Series

TAPE DIMENSIONS FOR STYLE T2 (for reference only) mm/[in]

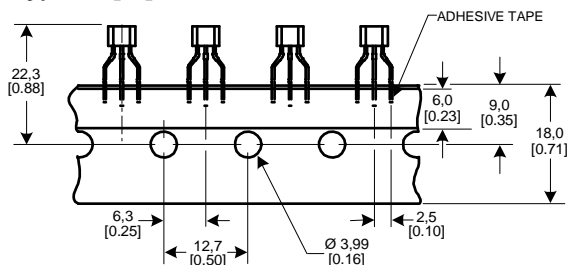

TAPE DIMENSIONS FOR STYLE T3 (for reference only) mm/[in]

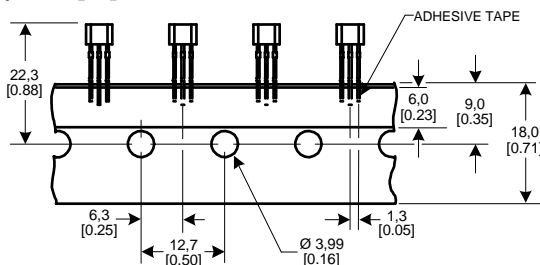

SS50AT SERIES MOUNTING DIMENSIONS (for reference only) mm/[in]

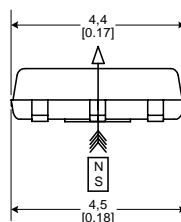
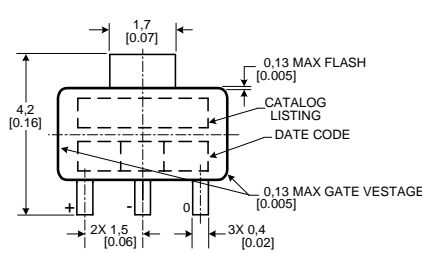
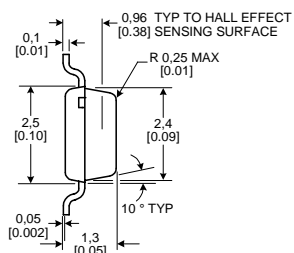

TAPE DIMENSIONS (for reference only) mm/[in]

This product is sold in tape and reel form only, per EIA STD 481. There are 1,000 parts per reel.

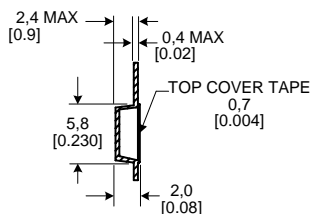
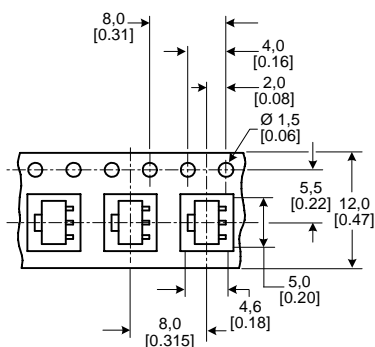

REEL DIMENSIONS (for reference only) mm/[in]

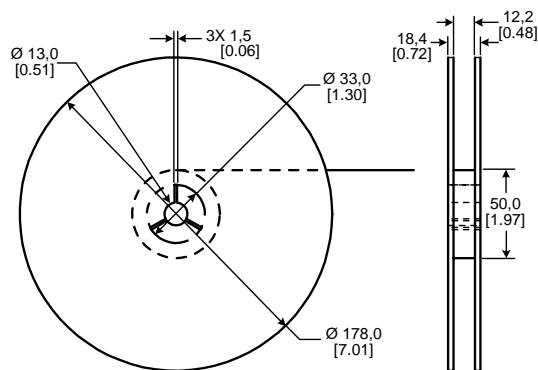

Magnetic Position Sensors

Low-Cost, Bipolar, Hall-effect Sensors

SS40A/SS50AT Series

ORDER GUIDE

Part Number	Description
SS40A	Bipolar, Hall-effect sensor, radial lead IC package
SS40A-F	Bipolar, Hall-effect sensor, radial lead IC package with formed leads on 2,54 mm [0.100 in] centers
SS40A-T2	Bipolar, Hall-effect sensor, radial lead IC package tape-in-box (ammopack) version with formed leads
SS40A-T3	Bipolar, Hall-effect sensor, radial lead IC package tape-in-box (ammopack) version with straight leads
SS50AT	Bipolar, Hall-effect sensor, surface-mount package, on tape and reel

WARRANTY/REMEDY

Honeywell warrants goods of its manufacture as being free of defective materials and faulty workmanship. Contact your local sales office for warranty information. If warranted goods are returned to Honeywell during the period of coverage, Honeywell will repair or replace without charge those items it finds defective. **The foregoing is Buyer's sole remedy and is in lieu of all other warranties, expressed or implied, including those of merchantability and fitness for a particular purpose.**

Specifications may change without notice. The information we supply is believed to be accurate and reliable as of this printing. However, we assume no responsibility for its use.

While we provide application assistance personally, through our literature and the Honeywell web site, it is up to the customer to determine the suitability of the product in the application.

For application assistance, current specifications, or name of the nearest Authorized Distributor, contact a nearby sales office. Or call:

1-800-537-6945 USA/Canada

1-815-235-6847 International

FAX

1-815-235-6545 USA

INTERNET

www.honeywell.com/sensing

info.sc@honeywell.com

Honeywell

Sensing and Control
www.honeywell.com/sensing

Honeywell
11 West Spring Street
Freeport, Illinois 61032