

## Super sealed CE Miniature limit switch

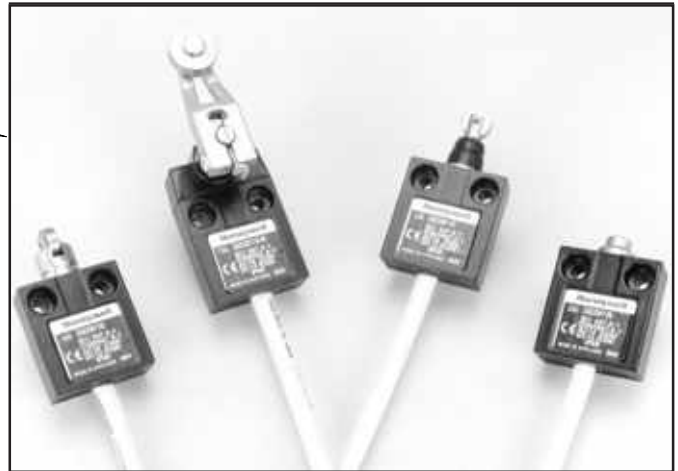

### Features

- Fully sealed - capable of working when submerged
- Compact construction
- Pre-wired or connector versions
- Die-cast zinc housing
- Wide selection of actuators
- Gang mounting capability
- Variable length PUR cable
- Side and bottom exit cable/connector
- Simple two-screw mounting
- IP66/67, IP68 sealing

### Benefits

- Suitable for difficult operating environments
- Suitable for applications where space is at a premium
- Fast and easy to install
- Application flexibility
- Multiple switching in small spaces
- Enhanced choice for application
- Suitable for aggressive environments

### Description

The Super sealed CE Series Miniature limit switch has been designed for reliability in the harshest of environments. Its robust design, corrosion limiting features, flexible PUR cable and super sealing allows it to operate fully submerged in a range of fluids. Its small size allows operation in confined spaces. A range of different actuators offers flexibility in application.

### Low energy switching

In today's demanding age of low energy controls, electromechanical switches are frequently used in interface directly with PLCs and other low energy devices. To accommodate this requirement Super sealed CE offers a gold plated contact version of the standard basic switch. This improves reliability of switching at low currents and voltages by protecting the contact surfaces from contamination during operation or storage prior to use. Standard silver contacts have the disadvantage in that the contact may tarnish under certain environmental conditions, e.g. in the presence of moisture.

Low energy basic switches are rated as follows:

Operating Voltage  $U_e$  1 to 50 Vac or Vdc

Operating Current  $I_e$  1 to 100 mA

### Electrical rating

		IEC947-5-1 / EN60947-5-1							
Designation & Utilization Category		Rated operational current $I_e$ (A) at rated operational voltage $U_e$						VA rating	
		120V	240V	380V	480V	500V	600V	Make	Break
AC15	A600	6	3	1.9	1.5	1.4	1.2	7200	720
AC15	A300	6	3	-	-	-	-	7200	720
AC15	B300	3	1.5	-	-	-	-	3800	360
AC14	D300	0.6	0.3	-	-	-	-	432	72
		125V 250V							
DC13	Q300	0.55	0.27					69	69
DC13	R300	0.22	0.1					28	28

### WARNING

#### MISUSE OF DOCUMENTATION

- The information presented in this product sheet (or catalogue) is for reference only. DO NOT USE this document as product installation information.
- Complete installation, operation and maintenance information is provided in the instructions supplied with each product.

**Failure to comply with these instructions could result in death or serious injury.**

# Super sealed CE Series Miniature enclosed switch

## Technical Data

Mechanical life	up to 10 million operations
Degree of protection	IP66/67, IP68
Temperature range	Operating: -40 °C to +90 °C (-40 °F to +194 °F)
Approvals/standards	IEC 60947-5-1 EN 60947-5-1 AC14 D300 DC13 R300
Electrical	Not suitable for isolation. SCPD, Quick blow fuse to IEC 127 suitable for rated current.
Shock	50 g conforming to IEC 68-2-27
Vibration	10 g conforming to IEC 68-2-6

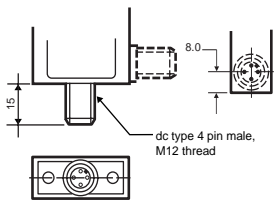
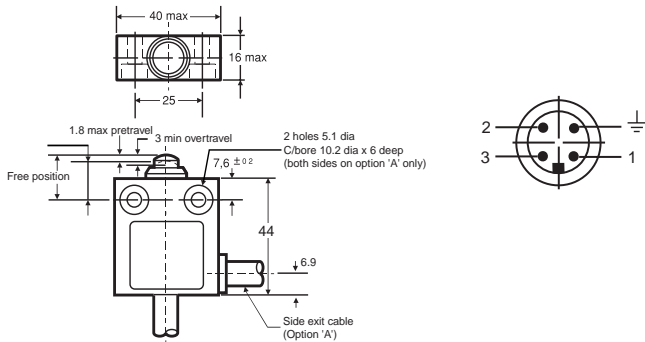

- Side exit PUR cable = **A**
- Bottom exit PUR cable = **B**
- Side exit connector = **C**
- Bottom exit connector = **D**

## Ordering Guide:

**SSCE** **X**

Cable/connector	Switch type Snap action contacts
<b>Connector</b> <b>0</b>	
<b>1 m</b> <b>1</b>	<p>If cable option is required, specify cable length in 1 metre increments, e.g.</p>
<b>2 m</b> <b>2</b>	
<b>3 m</b> <b>3</b>	
<p><b>Note:</b> 4 m to 9 m cable lengths available by special request only.</p>	

▲ Low energy contacts  
See page 1

**1**  
**7▲**

**Actuator type**

**Options (for actuator type 'A' only)**

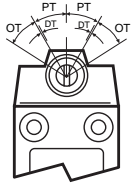

**Top Rotary action/lever**

**A**

See 'Options' for additional levers

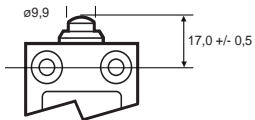

**Top Pin Plunger**

**B**

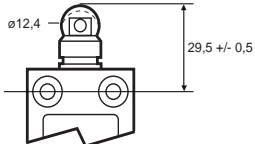

**Top Roller Plunger, Parallel**

**C**

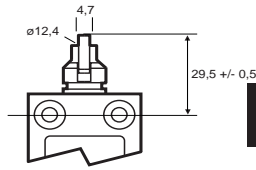

**Top Roller Plunger, Perpendicular**

**D**

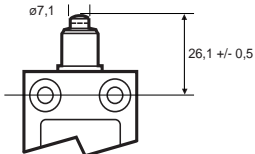

**Top Pin Plunger, Boot Sealed**

**E**

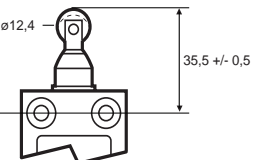

**Top Roller Plunger, Parallel, Boot Sealed**

**F**

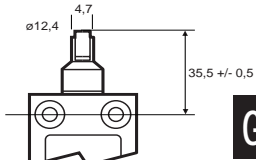

**Top Roller Plunger, Perpendicular, Boot Sealed**

**G**

**Fixed length lever plastic roller**

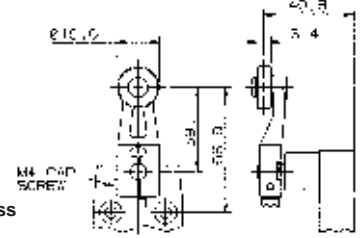

**1A**

**Fixed length lever stainless steel roller**

**1B**

**Adjustable length lever plastic roller**

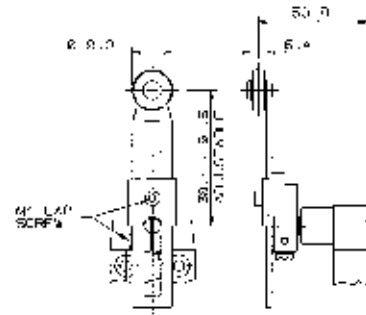

**2A**

**Adjustable length lever stainless steel roller**

**2B**

**Adjustable rod lever**

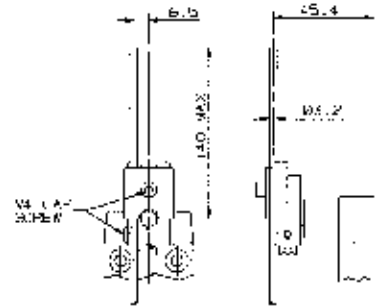

**4J**

**No lever (leave blank)**

**--**

**X**

**XX**