

Wireless Panel-Mount Monitor

Limitless™ Monitor



DESCRIPTION

The new Limitless™ product line combines the best of MICRO SWITCH™ limit switches with the latest commercial off-the-shelf wireless technology. The Wireless Panel Mount Monitor will provide a visual, audio and NPN output based on a

signal received from a Limitless™ switch. The Wireless Panel Mount Monitor will provide immediate indication of an actuator position change of the wireless limit switch.

FEATURES

Wireless electrical design

- Radio (license-free and global): WPAN 802.15.4, 2.4 GHz, point-to-point
- FCC 15, IC, ACMA and ETSI approvals
- EMI immunity
- Up to 304 m [1000 ft] line-of-sight communication range when used with a Limitless™ switch (sold separately)
- Reliable, flexible, and secure wireless transmission
- 10 Vdc to 30 Vdc supply with NPN Normally Open output
- Diagnostics options
- Can potentially monitor up to 16 wireless switches
- Field pairing function allows for rapid configuration (add or subtract switches)

Mechanical design

- Panel-mount enclosure (snap-in or screw mount)
- Polycarbonate, shock resistant, tamper-proof case
- Sealed to IP67
- Multiple LED function/status indicators with audible buzzer
- Direct or remote mount antenna

BENEFITS

- Ability to reconfigure and network multiple switches, or point-to-point with personalized addresses which allows for adding, subtracting or relocating Limitless™ switches easily
- Reduced installation/maintenance costs with no wiring to Limitless™ switches, conduit, strain relief, clips, connectors, connection boxes, etc.
- Snap-in panel or screw mount design allows flexibility in mounting locations
- LEDs/buzzer indicate Limitless™ switch actuation, low battery, RF signal loss, pairing function as well as diagnostic functions
- Communication security per the IEEE 802.15.4 standard (16-bit PAN (network) ID, 16-bit address and 128-bit security key)

POTENTIAL APPLICATIONS

- Valve position
- Crane boom/jib/skew position
- Lifts
- Material handling
- Presses
- Construction/Ag machines
- Conveyors
- Remote or temporary equipment
- Movable machinery
- Grain diverters or flaps
- Door position
- Hose attachment verification
- Specialty machines

Limitless™ Series

Description	Parameter
Product type	Limitless™ Panel Mount Monitor Series
Series name	WPMM Series
Availability	Global, license-free bands
Housing material	LCP, VECTRA E130i
Housing type	Snap-in panel or screw mount design
Radio type	WPAN 802.15.4, 2.4 GHz
Antenna type	Direct mount or remote antenna options; Omni directional
Signal range	Nominal 304 m* for International use (Europe and Australia due to signal restrictions); Nominal 1000 ft* for use in US and Canada *clear line of sight between Limitless™ switch and WPMM when using 2.1 dBi integral antenna
Supply voltage	10 Vdc to 30 Vdc
Supply current	750 mA
Output type	NPN current sinking; normally open
Load current	5 mA to 200 mA
Leakage current	50 uA max.
Voltage drop	1.75 Vdc max. @ max. load @ 25 °C [77 °F]
Terminal(s)	3
Termination	Quick connect, 0.25 in male blade
Sealing	IP67
Reverse polarity protection	Yes
EMC	Latest applicable standards: EN 300 328, V1.7.1; EN 61326-1 (2006); EN 301 489-1, V1.8.1; EN 301 489-17, V2.1.1
Shock	IEC 60068-2-27; half sine, 10 g, 6 mS, 3 axis
Vibration	IEC 60068-2-6; 10 Hz to 500 Hz w/ 0,35 mm peak-to-peak, 58 Hz to 500 Hz- 5g
Operating temperature	-40 °C to 85 °C [-40 °F to 185 °F]
Agency approvals and standards	FCC 15.247 Industry Canada RSS 210 ETSI, CE mark ACMA, C-Tick mark
UNSPSC code	20142601
UNSPSC commodity	20142601

* Actual range will vary depending on antenna, cables, and site topography.

STANDARD LIMITLESS™ WPMM LISTINGS

Part Number	Description
WPMM1A02A	Limitless™ WPMM Series Monitor, 2.1 dBi omni antenna (tilt & swivel design), for use in US/Canada
WPMM1A03A	Limitless™ WPMM Series Monitor, 3.0 dBi omni antenna with remote adhesive mounting with 9.8 ft cable, for use in US/Canada
WPMM1A04A	Limitless™ WPMM Series Monitor, 5.5 dBi omni antenna (tilt & swivel design) with remote magnetic mounting with 5 ft cable, for use in US/Canada
WPMM1A05A	Limitless™ WPMM Series Monitor, 5.5 dBi omni antenna (tilt & swivel design) with remote magnetic mounting with 10 ft cable, for use in US/Canada

Wireless Limit Switches

LIMITLESS WPMM DIMENSIONS

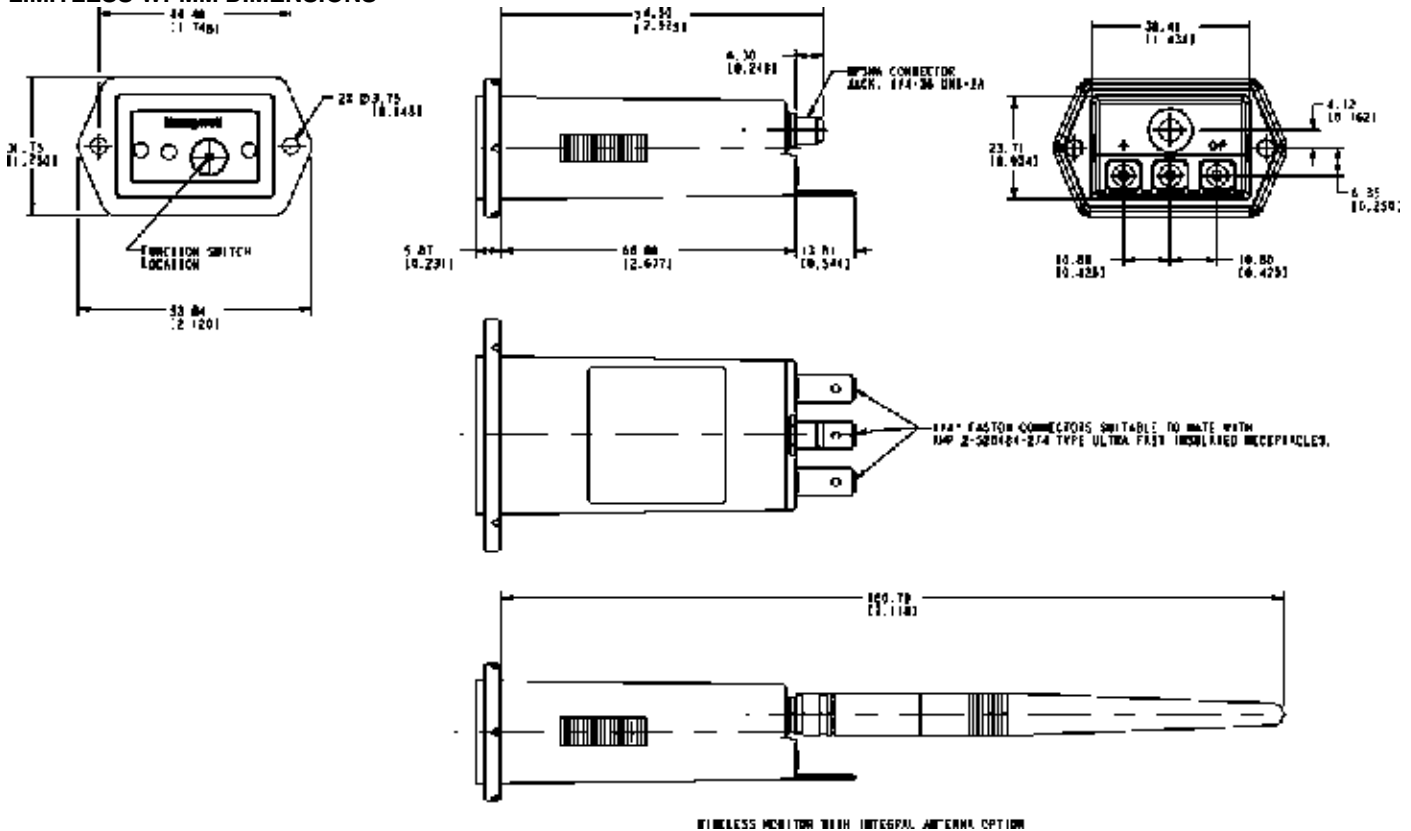

WPMM MONITOR NOMENCLATURE

WPMM	1	A	00	A	
Monitor type	Software version	RF Code	Antenna type code	Country use code	Specials
WPMM Series Monitor	1 Version 1	A 2.1 GHz, IEEE 802.15.1	00 1/2 wave, RF-SMA connector jack 01 21 dB omni w/ switch mount, STL design 02 21 dB omni w/ switch mount, STL and swivel design 03 3.5 dB omni w/ remote adhesive mountable cable 04 5.5 dB omni w/ remote adhesive mount, BLS w/ STL design 05 5.5 dB omni w/ remote adhesive mount, BLS w/ STL design 06 11 dB omni w/ remote adhesive mount, BLS w/ STL design 07 9.0 dB omni w/ remote adhesive mount, BLS w/ STL design 08 11 dB omni w/ remote adhesive mount, STL design 09 8.0 dB omni w/ remote adhesive mount, STL design	A US, Canada B European countries* C Australia	Use only if monitor has a special feature

*Antenna type codes 00 to 05 only

Limitless™ Series

LIMITLESS™ MOUNTING OPTIONS

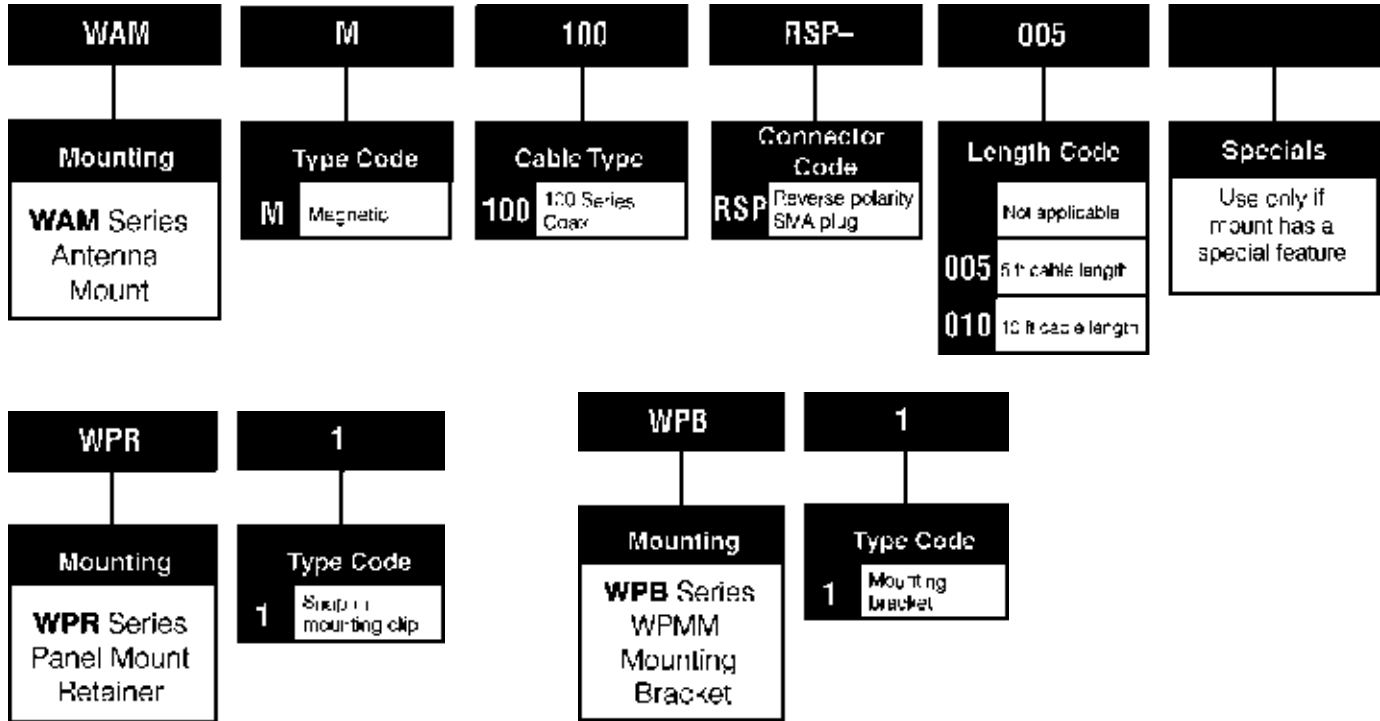

WAMM100RSP-005/010 Magnetic Antenna Mount



WPR1 Panel Mount Retainer



WPB1 WPMM Mounting Bracket



Wireless Limit Switches

LIMITLESS™ WPB BRACKET

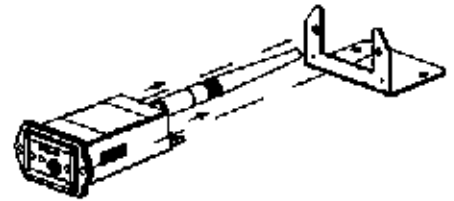
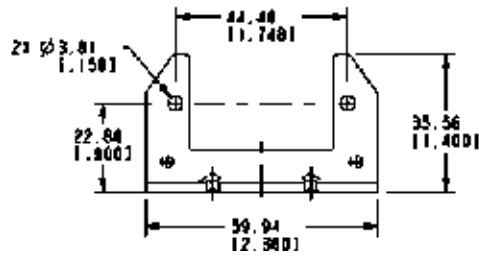
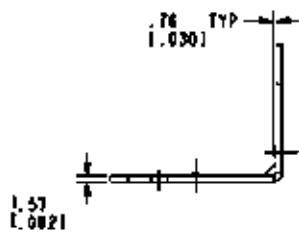
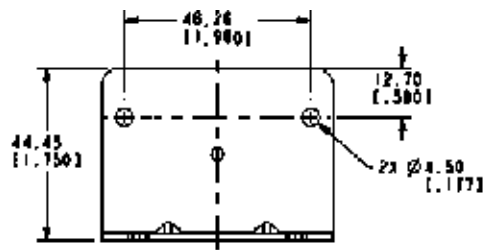

LIMITLESS™ WPR RETAINER

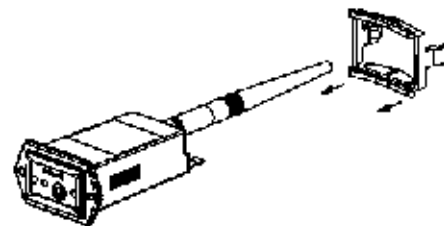
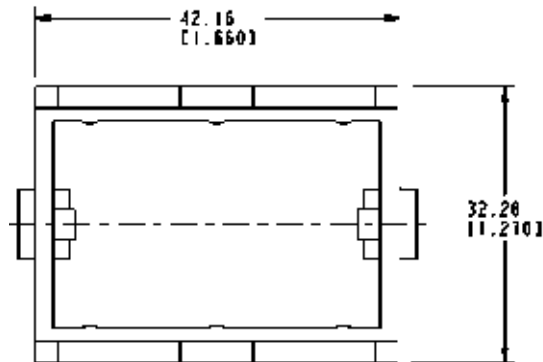
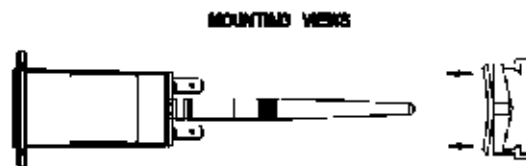
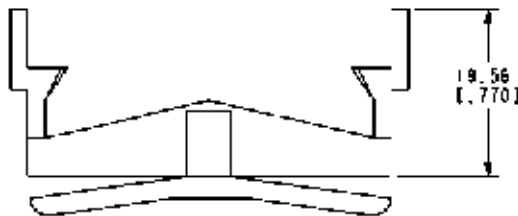





Limitless™ Series

LIMITLESS™ ANTENNA OPTIONS

WAN	01	RSP	---																
Antenna type	Antenna type code	Connector Code	Specials																
WAN Series Antenna	<table border="1"> <tr> <td>01</td> <td>2.1 dBi omni; straight design</td> </tr> <tr> <td>02</td> <td>2.1 dBi omni; tilt & swivel des.</td> </tr> <tr> <td>03</td> <td>3.0 dBi omni with adhesive mount & 8 ft cable</td> </tr> <tr> <td>04</td> <td>5.5 dBi omni; tilt & swivel des.</td> </tr> <tr> <td>05</td> <td>9.0 dBi omni; tilt & swivel des.</td> </tr> <tr> <td>06</td> <td>8.0 dBi omni w/ bracket, straight des. 1 ft cable</td> </tr> </table>	01	2.1 dBi omni; straight design	02	2.1 dBi omni; tilt & swivel des.	03	3.0 dBi omni with adhesive mount & 8 ft cable	04	5.5 dBi omni; tilt & swivel des.	05	9.0 dBi omni; tilt & swivel des.	06	8.0 dBi omni w/ bracket, straight des. 1 ft cable	<table border="1"> <tr> <td>RNJ</td> <td>Reverse polarity N jack**</td> </tr> <tr> <td>RSP</td> <td>Reverse polarity SMA plug</td> </tr> </table>	RNJ	Reverse polarity N jack**	RSP	Reverse polarity SMA plug	Use only if antenna has a special feature.
01	2.1 dBi omni; straight design																		
02	2.1 dBi omni; tilt & swivel des.																		
03	3.0 dBi omni with adhesive mount & 8 ft cable																		
04	5.5 dBi omni; tilt & swivel des.																		
05	9.0 dBi omni; tilt & swivel des.																		
06	8.0 dBi omni w/ bracket, straight des. 1 ft cable																		
RNJ	Reverse polarity N jack**																		
RSP	Reverse polarity SMA plug																		

** Only used with 05 antenna type code
 *** Limited outdoor exposure. Protect against direct rain, salt, snow, ice, etc.

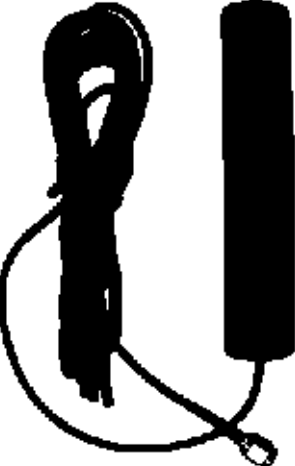
LIMITLESS™ ANTENNAS

WAN01RSP Straight Design Direct Mount Connector	WAN02RSP Tilt and Swivel Design, Direct Mount Antenna	WAN05RSP with WAMM100RSP-005 Tilt and Swivel Design, Magnetic Mount Antenna	WAN03RSP Flat Design, Adhesive Mount Antenna	WAN06RNJ Straight Design, Bracket Mount Antenna
				

Wireless Limit Switches

LIMITLESS™ ANTENNA CABLE OPTIONS

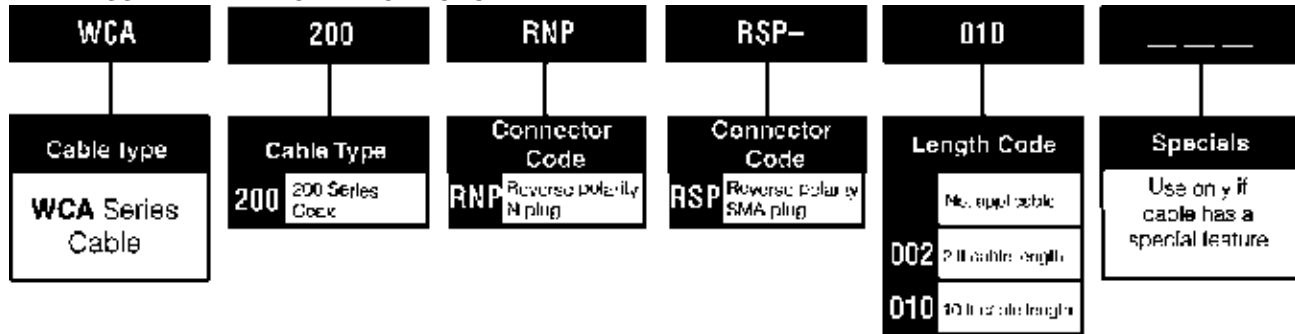

LIMITLESS™ CABLE ACCESSORIES

WCA200RNPRSP-002/010 Cable Assembly



Limitless™ Series

WARNING

PERSONAL INJURY

DO NOT USE these products as safety or emergency stop devices or in any other application where failure of the product could result in personal injury.

Failure to comply with these instructions could result in death or serious injury.

WARNING

MISUSE OF DOCUMENTATION

- The information presented in this product sheet is for reference only. Do not use this document as a product installation guide.
- Complete installation, operation, and maintenance information is provided in the instructions supplied with each product.

Failure to comply with these instructions could result in death or serious injury.

WARNING

Honeywell does not recommend using devices for critical control applications where there is, or may be, a single point of failure or where single points of failure may result in an unsafe condition. It is up to the end-user to weigh the risks and benefits to determine if the products are appropriate for the application based on security, safety and performance. Additionally, it is up to the end-user to ensure that the control strategy results in a safe operating condition if any crucial segment of the control solution fails.

Failure to comply with these instructions could result in death or serious injury.

WARRANTY/REMEDY

Honeywell warrants goods of its manufacture as being free of defective materials and faulty workmanship. Honeywell's standard product warranty applies unless agreed to otherwise by Honeywell in writing; please refer to your order acknowledgement or consult your local sales office for specific warranty details. If warranted goods are returned to Honeywell during the period of coverage, Honeywell will repair or replace, at its option, without charge those items it finds defective. **The foregoing is buyer's sole remedy and is in lieu of all other warranties, expressed or implied, including those of merchantability and fitness for a particular purpose. In no event shall Honeywell be liable for consequential, special, or indirect damages.**

While we provide application assistance personally, through our literature and the Honeywell web site, it is up to the customer to determine the suitability of the product in the application.

Specifications may change without notice. The information we supply is believed to be accurate and reliable as of this printing. However, we assume no responsibility for its use.

SALES AND SERVICE

Honeywell serves its customers through a worldwide network of sales offices, representatives and distributors. For application assistance, current specifications, pricing or name of the nearest Authorized Distributor, contact your local sales office or:

E-mail: info.sc@honeywell.com

Internet: www.honeywell.com/sensing

Phone and Fax:

Asia Pacific	+65 6355-2828
	+65 6445-3033 Fax
Europe	+44 (0) 1698 481481
	+44 (0) 1698 481676 Fax
Latin America	+1-305-805-8188
	+1-305-883-8257 Fax
USA/Canada	+1-800-537-6945
	+1-815-235-6847
	+1-815-235-6545 Fax