

MICRO SWITCH Magnetically Actuated Non-Contact Safety Switches, FF2 and FF3 Series

004748

Issue 3

Datasheet



DESCRIPTION

The FF2 Series and FF3 Series are magnetically actuated non-contact safety switches incorporated into a threaded plastic housing for use in machine guarding applications. These Series of switches provide a preferred solution where misalignment between guards, gates, or doors can occur and locking of the guard, gate, or door is not required. The FF2 Series is designed with an 18 mm threaded diameter plastic housing while the FF3 Series has a 30 mm threaded diameter plastic housing. The threaded magnetic actuator of respective size (18 mm or 30 mm) and hex mounting hardware are included with each switch. The FF2 and FF3 Series are certified to CE and UL. The switches and actuators are sealed to IP67 for wet or dusty environments.

VALUE TO CUSTOMERS

- Non-contact sensing minimizes installation and set-up time
- Ø18 mm or Ø30 mm mounting for switch and actuator simplifies installation
- Cable with color coded individual wire leads integral to switch reduces installation
- Target can approach switch from head-on, slide by, or rotational/hinge for flexible installation

FEATURES

- Tough ABS threaded plastic housing in a Ø18 mm or Ø 30 mm for switch and actuator
- Option of one or two safety contacts (normally closed when target is present)
- Optional auxiliary monitoring contact (normally closed when target is not sensed)
- CE and UL508 Certifications

POTENTIAL APPLICATIONS

- Equipment and machinery guards
- Can forming and filling (aluminum, steel, and plastic)
- Pick-and-place packaging equipment
- Pick-and-place assembly equipment
- Plastic molding equipment
- Printing machinery
- Semiconductor equipment
- Textile machinery
- Woodworking machinery

DIFFERENTIATION

- Non-contact sensing, requires no mechanical linkage to actuate switch
- Threaded housing for switch and actuator for ease of installation
- Choice of one or two safety contacts to close when actuated
- Optional auxiliary contact closes when actuator moves out of the operating range

PORTFOLIO

Honeywell offers a wide range of FF Series magnetically actuated non-contact switches as well as other non-interlocking safety switches which include the GSS Series electromechanical limit switches, and the cable/rope pull switches (1CPS Series single head and 2CPS Series dual head). Honeywell safety interlocking switches include the metal housing EN50041 GK Series, metal housing solenoid GKL/R Series, miniature plastic housing GKM Series, EN50047 plastic housing GKE Series, and plastic housing GKN Series.

Magnetically Actuated Non-Contact Safety Switches, FF2 and FF3 Series

Table 1. Performance Specifications

Characteristic	Parameter			
	FF2-10-AC (Ø18) FF2-11-AC (Ø18)	FF2-10-DC (Ø18) FF2-11-DC (Ø18)	FF3-20-AC (Ø30) FF3-21-AC (Ø30)	FF3-20-DC (Ø30) FF3-21-DC (Ø30)
Contact arrangement	1NC (FF2-10-AC) 1NC/1NO (FF2-11-AC)	1NC (FF2-10-DC) 1NC/1NO (FF2-11-DC)	2NC (FF3-20-AC) 2NC/1NO (FF3-21-AC)	2NC (FF3-20-AC) 2NC/1NO (FF3-21-AC)
Contact rating (safety contact)	2 A @ 230 Vac	1 A ind./res. @ 30 Vdc	2 A @ 230 Vac	1 A ind./res. @ 30 Vdc
Sensing distance* (safety contact)	10 mm [0.4 in] ON 30 mm [1.18 in] OFF	10 mm [0.4 in] ON 30 mm [1.18 in] OFF	10 mm [0.4 in] ON 35 mm [1.38 in] OFF	10 mm [0.4 in] ON 35 mm [1.38 in] OFF
Close/drop-out/bounce (safety contact)	3 ms/2.1 ms/0.7 ms	3 ms/2.1 ms/0.7 ms	3 ms/2.1 ms/0.7 ms	3 ms/2.1 ms/0.7 ms
Contact rating (aux. contact)	15 W/10 VA	15 W/10 VA	15 W/10 VA	15 W/10 VA
Sensing distance* (aux. contact)	7 mm [0.28 in] OFF 14 mm [0.55 in] ON	7 mm [0.28 in] OFF 14 mm [0.55 in] ON	7 mm [0.28 in] OFF 20 mm [0.79 in] ON	7 mm [0.28 in] OFF 20 mm [0.79 in] ON
Close/drop-out/bounce (aux. contact)	0.5 ms/0.3 ms/0.7 ms	0.5 ms/0.3 ms/0.7 ms	0.5 ms/0.3 ms/0.7 ms	0.5 ms/0.3 ms/0.7 ms
Internal fuse**	ac: 2 A fast acting	dc: 1 A fast acting	ac: 2 A fast acting	dc: 1 A fast acting
External fuse ** (customer supplied)	ac: 1.6 A fast acting	dc: 0.8 A fast acting	ac: 1.6 A fast acting	dc: 0.8 A fast acting
Environmental seal rating	IP67	IP67	IP67	IP67
Vibration/shock	50 Hz to 100 Hz/10g	50 Hz to 100 Hz/10g	50 Hz to 100 Hz/10g	50 Hz to 100 Hz/10g
Operating temperature	-10°C to 55°C [14°F to 131°F]	-10°C to 55°C [14°F to 131°F]	-10°C to 55°C [14°F to 131°F]	-10°C to 55°C [14°F to 131°F]
Housing material	ABS resin filled	ABS resin filled	ABS resin filled	ABS resin filled
Mounting & alignment	Actuator & switch concentric when safety contact actuated	Actuator & switch concentric when safety contact actuated	Actuator & switch concentric when safety contact actuated	Actuator & switch concentric when safety contact actuated
Agency certifications	CE and UL	CE and UL	CE and UL	CE and UL

*Sensing distance is from surface of switch to surface of magnetic actuator.

**All safety contacts should be fused externally as the internal fuse is not resettable.

Table 2. Connections

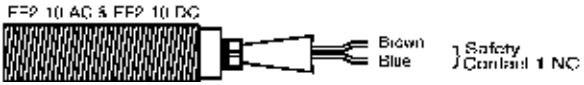
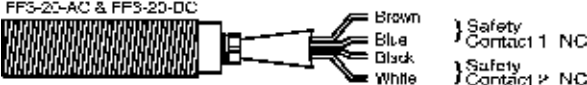
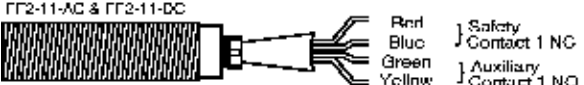
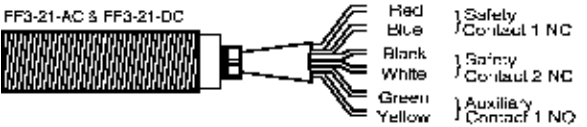
FF2-10	FF3-20
<p>FF2-10-AC & FF2-10-DC</p> 	<p>FF3-20-AC & FF3-20-DC</p> 
FF2-11	FF3-21
<p>FF2-11-AC & FF2-11-DC</p> 	<p>FF3-21-AC & FF3-21-DC</p> 

Magntically Actuated Non-Contact Safety Switches, FF2 and FF3 Series

Table 3. Contacts

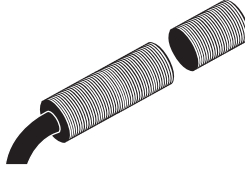
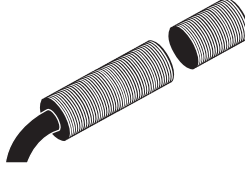
FF2	
<p>FF2-11-AC-03 FF2-11-DC-03</p> <p>Red — Blue Green — Yellow</p>	<p>FF2-10-AC-03 FF2-10-DC-03</p> <p>Brown — Blue</p>
	
FF3	
<p>FF3-21-AC-03 FF3-21-DC-03</p> <p>Red — Blue Black — White Green — Yellow</p>	<p>FF3-20-AC-03 FF3-20-DC-03</p> <p>Brown — Blue Black — White</p>
	

NOTE: Contact configurations shown under closed condition for guard device. Actuator has energized switch contacts, as show.

Table 4. Order Guide

Catalog Listing	Description
FF2-10-AC-03	Safety switch, Ø18 mm [0.71 in] 1NC, ac, 3 m pre-wired
FF2-11-AC-03	Safety switch, Ø18 mm [0.71 in] 1NC/1NO, ac, 3 m pre-wired
FF2-10-DC-03	Safety switch, Ø18 mm [0.71 in] 1NC, dc, 3 m pre-wired
FF2-11-DC-03	Safety switch, Ø18 mm [0.71 in] 1NC/1NO, dc, 3 m pre-wired
FF3-20-AC-03	Safety switch, Ø30 mm [1.18 in] 2NC, ac, 3 m pre-wired
FF3-21-AC-03	Safety switch, Ø30 mm [1.18 in] 2NC/1NO, ac, 3 m pre-wired
FF3-20-DC-03	Safety switch, Ø30 mm [1.18 in] 2NC, dc, 3 m pre-wired
FF3-21-DC-03	Safety switch, Ø30 mm [1.18 in] 2NC/1NO, dc, 3 m pre-wired

Figure 1. Product Dimensions

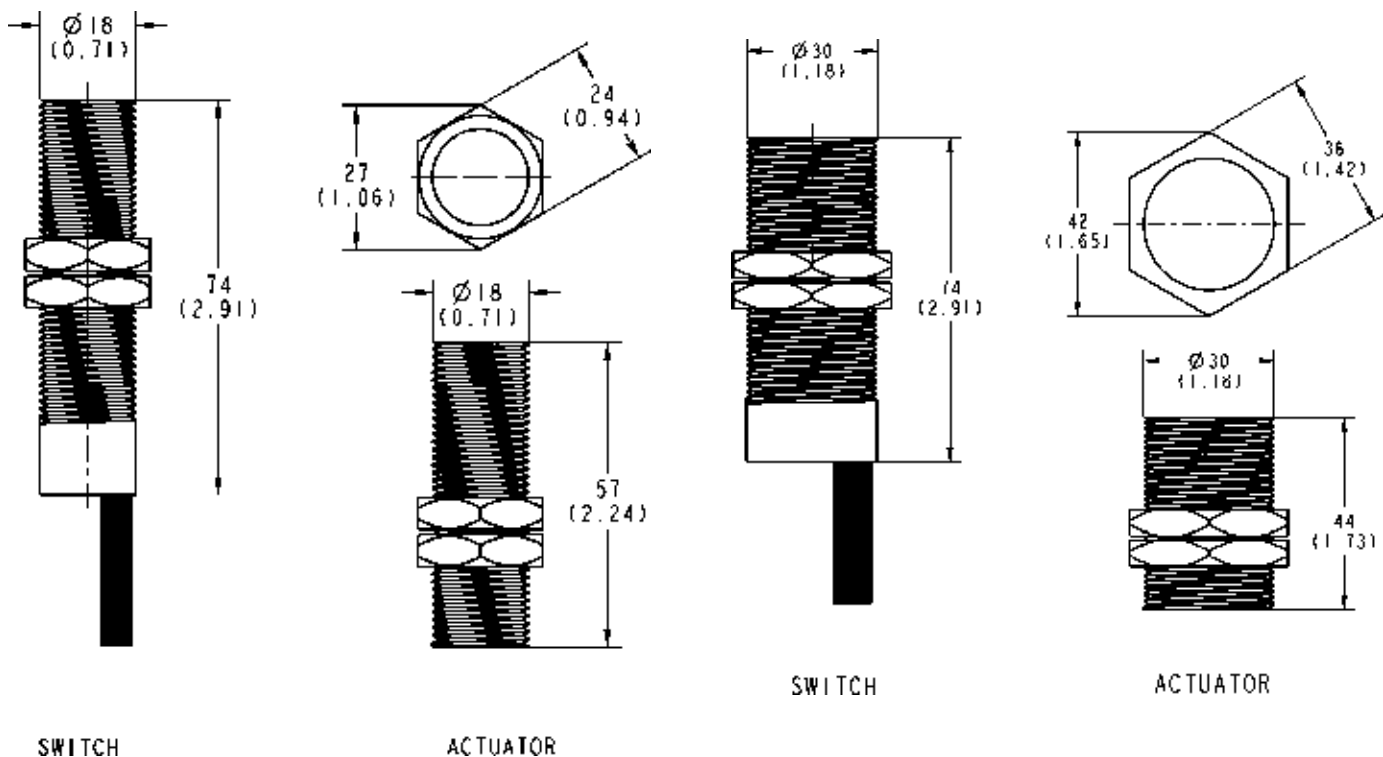

ADDITIONAL MATERIALS

The following associated literature is available on the Honeywell web site at sensing.honeywell.com:

- Product installation instructions
- Product range guide

Find out more

Honeywell serves its customers through a worldwide network of sales offices, representatives and distributors. For application assistance, current specifications, pricing or name of the nearest Authorized Distributor, contact your local sales office.

To learn more about Honeywell's sensing and control products,

call **+1-815-235-6847** or **1-800-537-6945**,

visit **sensing.honeywell.com**,
or e-mail inquiries to
info.sc@honeywell.com

Honeywell Sensing and Internet of Things

9680 Old Bailes Road
Fort Mill, SC 29707
honeywell.com

WARNING **IMPROPER INSTALLATION**

- Consult with local safety agencies and their requirements when designing a machine-control link, interface and all control elements that affect safety.
- Strictly adhere to all installation instructions.

Failure to comply with these instructions could result in death or serious injury.

WARNING **MISUSE OF DOCUMENTATION**

- The information presented in this product sheet is for reference only. Do not use this document as a product installation guide.
- Complete installation, operation, and maintenance information is provided in the instructions supplied with each product.

Failure to comply with these instructions could result in death or serious injury.

Warranty/Remedy

Honeywell warrants goods of its manufacture as being free of defective materials and faulty workmanship during the applicable warranty period. Honeywell's standard product warranty applies unless agreed to otherwise by Honeywell in writing; please refer to your order acknowledgment or consult your local sales office for specific warranty details. If warranted goods are returned to Honeywell during the period of coverage, Honeywell will repair or replace, at its option, without charge those items that Honeywell, in its sole discretion, finds defective. **The foregoing is buyer's sole remedy and is in lieu of all other warranties, expressed or implied, including those of merchantability and fitness for a particular purpose. In no event shall Honeywell be liable for consequential, special, or indirect damages.**

While Honeywell may provide application assistance personally, through our literature and the Honeywell web site, it is buyer's sole responsibility to determine the suitability of the product in the application.

Specifications may change without notice. The information we supply is believed to be accurate and reliable as of this writing. However, Honeywell assumes no responsibility for its use.

Honeywell