

## MICRO SWITCH Hazardous Area Switches

BX | BX2 Series

002306

Issue 8

**Datasheet**



### DESCRIPTION

The MICRO SWITCH BX/BX2 Series are designed for applications in hazardous or explosive environments requiring a rugged, durable switch virtually anywhere in the world. To comply with explosion-proof switching requirements, the flame path within the switch housing is designed to contain and cool escaping hot gases and fumes that could cause an explosion outside of the switch. Regardless of where the equipment or machinery is designed, built, or installed, BX and BX2 Series products carry global agency coverage.

Honeywell offers two versions of the BX series switch: the standard BX Series features an aluminum housing, while the BX2 series features a 316L stainless steel housing. The stainless steel housing adds additional resistance against corrosion in applications exposed to aggressive, caustic agents, as well as those often present in chemical processing plants, off-shore/near-shore sites, and other hazardous areas. Both products are weather sealed for outdoor use and designed for explosive gas/dust environments. All operating heads of the BX/BX2 Series are field adjustable at 90° increments.

### DIFFERENTIATION

- Top-of-the-line environmental sealing combined with Honeywell expertise for hazardous location package design provides the right product for the right application
- Exclusive teller tab on levers ensures proper torque. When the tab cannot be moved, the lever is tight enough to prevent slippage

### FEATURES

- Approvals: UL, CSA, ATEX (CE), IEC Ex, INMETRO (Brazil), NEPSI Ex (China), KOSHA (select listings - Korea), and EAC (formerly GOST-R, Russia)
- Sealed to IP67, NEMA 1, 3, 4, 6, 13
- Industry-leading breadth of products
- Two rugged designs are available: aluminum or corrosion-resistant stainless steel head and body
- A diaphragm seal between head and body provides an extra measure of protection
- Optional fluorocarbon seals are available for harsh chemical or higher temperature environments
- Secure head-to-body retention with the head in any one of four positions 90° apart
- Self-lifting pressure plate terminals saves wiring time.
- Wide variety of non-sparking actuators, switch options, and head styles for design flexibility
- Rotary actuated heads are field adjustable for CW actuation, CCW actuation, or both to reduce inventory
- Choice of silver or gold-plated contacts

### APPLICATIONS

- Grain elevators
- Control valves and actuators
- Off-shore and on-shore drilling
- Pipelines
- Petrochemical and chemical plants
- Water treatment plants
- Paint booths
- Conveyors (above-ground)
- Pulp and paper
- Hazardous waste handling

### VALUE TO CUSTOMERS

- Around-the-world use in hazardous areas with international approvals: UL, CSA, ATEX (CE), IEC Ex, INMETRO, KOSHA, NEPSI Ex (China), and EAC (formerly GOST-R, Russia)
- Industry-leading breadth of product offering that includes: BX (aluminum housing) and BX2 (stainless steel housing) limit switches for hazardous locations
- 303 stainless steel operating shaft on sintered bronze bearing for enhanced mechanical life and operational reliability

### PORTFOLIO

Honeywell offers a wide range of limit switches in different size packages and hazardous environments. These limit switches include the BX/BX2 Series, CX Series, EX Series, LSX Series, GXS Series, and 14CE100 Series. To view the entire product portfolio, click [here](#).

# MICRO SWITCH Hazardous Area Switches, BX | BX2 Series

**Figure 1. MICRO SWITCH BX Series Features and Options**

The MICRO SWITCH BX2 limit switch has similar features, except a 316L stainless steel head and body without epoxy coating.

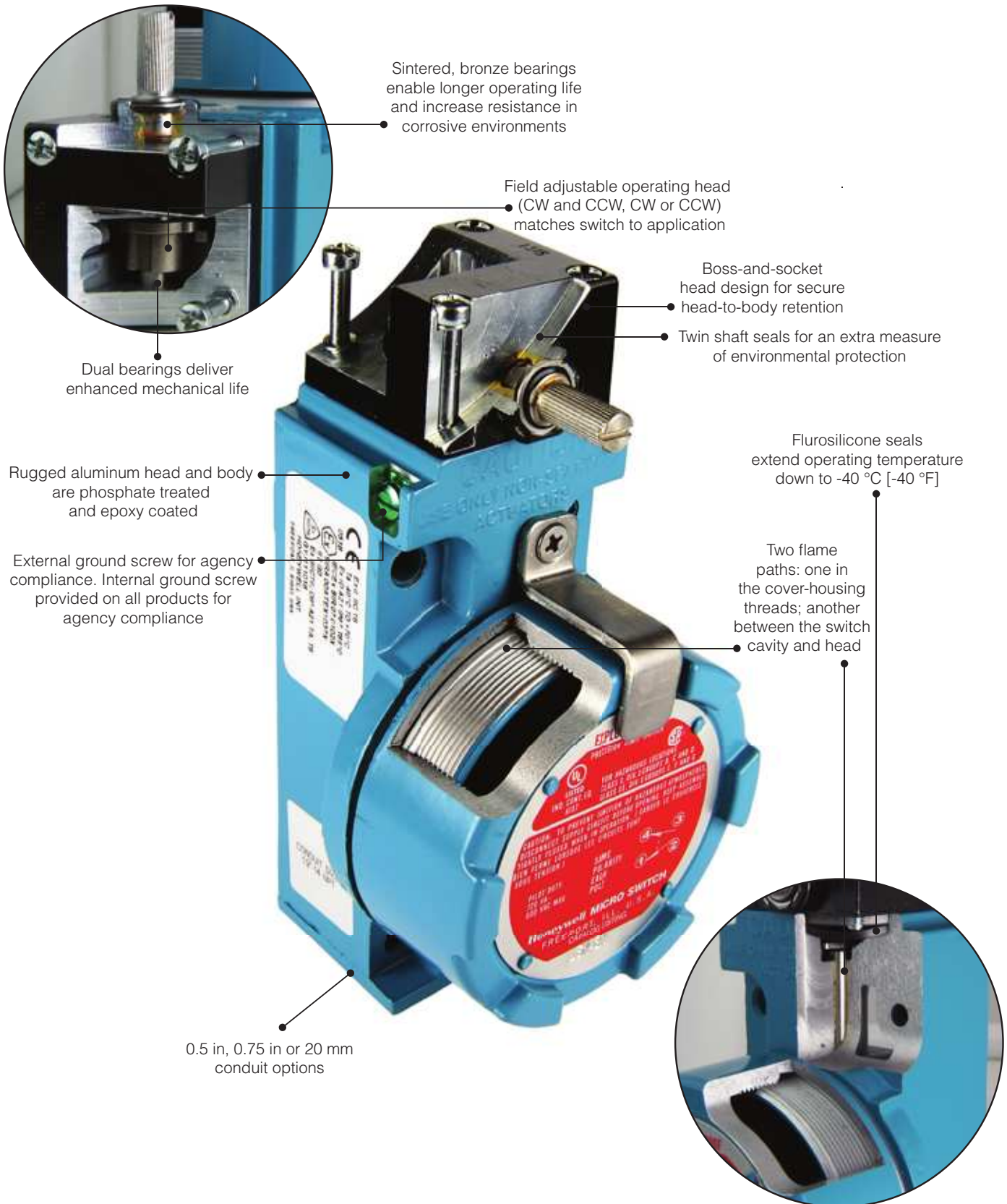

# MICRO SWITCH Hazardous Area Switches, BX | BX2 Series

Figure 2. MICRO SWITCH BX Series Product Nomenclature

| <b>BX</b>                                                                    |                                                                                                            | <b>F</b>                                              | <b>3K</b>                                                                           |                                                                                     | -                                                                                |                                                                            |
|------------------------------------------------------------------------------|------------------------------------------------------------------------------------------------------------|-------------------------------------------------------|-------------------------------------------------------------------------------------|-------------------------------------------------------------------------------------|----------------------------------------------------------------------------------|----------------------------------------------------------------------------|
| Switch Type                                                                  | Conduit Threads                                                                                            | Head Style*                                           | Body/Basic Switch Code                                                              | Actuator Modification                                                               | Actuator Options                                                                 |                                                                            |
| <b>BX</b> Series<br>Aluminum<br>Hazardous<br>Area<br>Limit Switch            | ½ or ¾ NPT**                                                                                               | <b>A</b> * Side rotary; momentary                     | <b>1A</b> 3NC/1NO, slow acting, 3/4 -14 NPT                                         | <b>1</b> CW rotation                                                                | <b>1A</b> * Fixed Ø 0.75 in x 0.25 in W nylon roller, 1.5 in radius, front mount |                                                                            |
|                                                                              | <b>4</b> 20 mm                                                                                             | <b>B</b> Top rotary; momentary                        | <b>1E</b> 3NC/1NO, slow acting, 3/4 -14 NPT gold-plated contacts                    | <b>2</b> CCW rotation                                                               | <b>1C</b> * Fixed Ø 0.75 in x 0.25 in W nylon roller, 1.5 in radius, back mount  |                                                                            |
| <b>BX2</b> Series<br>Stainless<br>Steel<br>Hazardous<br>Area<br>Limit Switch | ** see Body/Basic Switch Code column                                                                       | <b>C</b> * Top pin plunger, momentary                 | <b>3E</b> 1NC/1NO, snap action, 1/2 -14 NPT gold-plated contacts                    | <b>3</b> Right-oriented actuator head assembly                                      | <b>2A</b> * Adjustable, Ø 0.75 in x 0.25 in W nylon roller, front mount          |                                                                            |
|                                                                              | NOTE: if 1/2 NPT or 3/4 NPT conduit is desired, no code is necessary. Leave blank.                         | <b>D</b> * Top roller plunger, momentary              | <b>3K</b> 1NC/1NO, snap action, 1/2 -14 NPT                                         | <b>4</b> Left-oriented actuator head assembly                                       | <b>2C</b> * Adjustable, Ø 0.75 in x 0.25 in W nylon roller, back mount           |                                                                            |
|                                                                              | <b>If conduit code "4" in this column is selected, conduit in Body/Basic Switch column does not apply.</b> | <b>E</b> * Side pin plunger; momentary                | <b>4K</b> 1NC/1NO, snap action, 3/4 -14 NPT                                         | <b>Δ 4K</b> 1NC/1NO, snap action, 3/4 -14 NPT                                       | <b>5</b> Head assembled with actuator to mounting surface                        | <b>2J</b> Adjustable, Ø 1.0 in x 0.5 in W nylon roller, front mount        |
|                                                                              |                                                                                                            | <b>F</b> * Side roller plunger; momentary             | <b>4L</b> 2NC/2NO, snap action, 3/4 -14 NPT                                         | <b>4L</b> 2NC/2NO, snap action, 3/4 -14 NPT                                         | <b>6</b> Roller perpendicular to mounting surface                                | <b>2K</b> Adjustable, Ø 1.0 in x 0.5 in W nylon roller, back mount         |
|                                                                              |                                                                                                            | <b>H</b> * Side rotary, momentary; low PT, low torque | <b>4M</b> 2NC/2NO, snap action, sequential, 3/4 -14 NPT                             | <b>4M</b> 2NC/2NO, snap action, sequential, 3/4 -14 NPT                             | <b>8</b> Roller parallel to mounting surface                                     | <b>3S</b> Yoke, Ø 0.75 in x 0.25 in W nylon rollers, same side, back mount |
|                                                                              |                                                                                                            | <b>J</b> Wobble stick                                 | <b>4N</b> 2NC/2NO, snap action, center neutral, 3/4 -14 NPT                         | <b>4N</b> 2NC/2NO, snap action, center neutral, 3/4 -14 NPT                         |                                                                                  | <b>4M</b> Hub rod, aluminum                                                |
|                                                                              |                                                                                                            | <b>K</b> Cat whisker                                  | <b>4S</b> 2NC/2NO, snap action, 3/4 -14 NPT gold-plated contacts                    | <b>4S</b> 2NC/2NO, snap action, 3/4 -14 NPT gold-plated contacts                    |                                                                                  | <b>5A</b> Offset, Ø 0.75 in x 0.25 in W nylon roller, back mount           |
|                                                                              |                                                                                                            | <b>L</b> * Side rotary; sequential, momentary         | <b>4T</b> 2NC/2NO, snap action, sequential, 3/4 -14 NPT, gold-plated contacts       | <b>4T</b> 2NC/2NO, snap action, sequential, 3/4 -14 NPT, gold-plated contacts       |                                                                                  | <b>5C</b> Offset, Ø 0.75 in x 0.25 in W nylon roller, front mount          |
|                                                                              |                                                                                                            | <b>M</b> * Side rotary; central neutral, momentary    | <b>4U</b> 2NC/2NO, snap action, center neutral, 3/4 -14 NPT, gold-plated contacts   | <b>4U</b> 2NC/2NO, snap action, center neutral, 3/4 -14 NPT, gold-plated contacts   |                                                                                  | <b>7A</b> Plastic wobble stick                                             |
|                                                                              |                                                                                                            | <b>N</b> * Side rotary; maintained                    | <b>Δ 7L</b> 2NC/2NO, snap action, 1/2 -14 NPT                                       | <b>Δ 7L</b> 2NC/2NO, snap action, 1/2 -14 NPT                                       |                                                                                  | <b>8A</b> Cat whisker, 5.5 in                                              |
|                                                                              |                                                                                                            | <b>P</b> * Side rotary, momentary; low PT and DT      | <b>Δ 7N</b> 2NC/2NO, snap action, center neutral, 1/2 -14 NPT                       | <b>Δ 7N</b> 2NC/2NO, snap action, center neutral, 1/2 -14 NPT                       |                                                                                  |                                                                            |
|                                                                              |                                                                                                            | <b>R</b> * Side rotary, momentary; low torque         | <b>Δ 7S</b> 2NC/2NO, snap action, 1/2 -14 NPT gold-plated contacts                  | <b>Δ 7S</b> 2NC/2NO, snap action, 1/2 -14 NPT gold-plated contacts                  |                                                                                  |                                                                            |
|                                                                              |                                                                                                            | <b>V</b> Top pin plunger, adjustable, momentary       | <b>Δ 7T</b> 2NC/2NO, snap action, sequential, 1/2 -14 NPT, gold-plated contacts     | <b>Δ 7T</b> 2NC/2NO, snap action, sequential, 1/2 -14 NPT, gold-plated contacts     |                                                                                  |                                                                            |
|                                                                              |                                                                                                            | <b>W</b> Side pin plunger, adjustable, momentary      | <b>Δ 7U</b> 2NC/2NO, snap action, center neutral, 1/2 -14 NPT, gold-plated contacts | <b>Δ 7U</b> 2NC/2NO, snap action, center neutral, 1/2 -14 NPT, gold-plated contacts |                                                                                  |                                                                            |

Δ Not available with conduit code 4.

\* BX2 stainless steel "head styles" and "actuators" available

To order fluorocarbon versions, insert the additional letter **C** in the appropriate places in the standard catalog listing, as shown below:

|               |                                       |
|---------------|---------------------------------------|
| <b>BXA3K</b>  | standard, side-rotary switch          |
| <b>BXAC3K</b> | completely FC-sealed version of BXA3K |







# MICRO SWITCH Hazardous Area Switches, BX | BX2 Series

**Table 1. Specifications**

| Characteristic                      | Parameter                                                                                                                                                                                                                                                                                                                                                                                                       |                     |                               |                     |             |                        |                 |                              |                    |            |                      |                      |  |
|-------------------------------------|-----------------------------------------------------------------------------------------------------------------------------------------------------------------------------------------------------------------------------------------------------------------------------------------------------------------------------------------------------------------------------------------------------------------|---------------------|-------------------------------|---------------------|-------------|------------------------|-----------------|------------------------------|--------------------|------------|----------------------|----------------------|--|
| <b>Product type</b>                 | MICRO SWITCH hazardous area limit switches                                                                                                                                                                                                                                                                                                                                                                      |                     |                               |                     |             |                        |                 |                              |                    |            |                      |                      |  |
| <b>Actuators</b>                    | <table border="0"> <tr> <td>Side pin plunger</td> <td>Side pin plunger - adjustable</td> <td>Side roller plunger</td> </tr> <tr> <td>Side rotary</td> <td>Side rotary maintained</td> <td>Top pin plunger</td> </tr> <tr> <td>Top pin plunger - adjustable</td> <td>Top roller plunger</td> <td>Top rotary</td> </tr> <tr> <td>Wobble - cat whisker</td> <td>Wobble - plastic rod</td> <td></td> </tr> </table> | Side pin plunger    | Side pin plunger - adjustable | Side roller plunger | Side rotary | Side rotary maintained | Top pin plunger | Top pin plunger - adjustable | Top roller plunger | Top rotary | Wobble - cat whisker | Wobble - plastic rod |  |
| Side pin plunger                    | Side pin plunger - adjustable                                                                                                                                                                                                                                                                                                                                                                                   | Side roller plunger |                               |                     |             |                        |                 |                              |                    |            |                      |                      |  |
| Side rotary                         | Side rotary maintained                                                                                                                                                                                                                                                                                                                                                                                          | Top pin plunger     |                               |                     |             |                        |                 |                              |                    |            |                      |                      |  |
| Top pin plunger - adjustable        | Top roller plunger                                                                                                                                                                                                                                                                                                                                                                                              | Top rotary          |                               |                     |             |                        |                 |                              |                    |            |                      |                      |  |
| Wobble - cat whisker                | Wobble - plastic rod                                                                                                                                                                                                                                                                                                                                                                                            |                     |                               |                     |             |                        |                 |                              |                    |            |                      |                      |  |
| <b>Circuitry</b>                    | 1NC 1NO SPDT snap action, double break<br>2NC 2NO DPDT snap action, double break<br>2NC 2NO DPDT snap action, double break, sequential<br>2NC 2NO DPDT snap action, double break, center neutral<br>3NC 1NO slow action, double break                                                                                                                                                                           |                     |                               |                     |             |                        |                 |                              |                    |            |                      |                      |  |
| <b>Electrical</b>                   | 10 A thermal<br>Single and double pole: AC15 A600; DC13 R300 (see table on page 5)                                                                                                                                                                                                                                                                                                                              |                     |                               |                     |             |                        |                 |                              |                    |            |                      |                      |  |
| <b>Housing material</b>             | Aluminum (BX) or Stainless Steel (BX2)                                                                                                                                                                                                                                                                                                                                                                          |                     |                               |                     |             |                        |                 |                              |                    |            |                      |                      |  |
| <b>Termination types</b>            | 0.5 in - 14 NPT conduit<br>0.75 in - 14 NPT conduit<br>20 mm conduit                                                                                                                                                                                                                                                                                                                                            |                     |                               |                     |             |                        |                 |                              |                    |            |                      |                      |  |
| <b>Housing type</b>                 | BX/BX2 non-plug-in                                                                                                                                                                                                                                                                                                                                                                                              |                     |                               |                     |             |                        |                 |                              |                    |            |                      |                      |  |
| <b>Sealing</b>                      | NEMA 1, 3, 4, 6, 13; IP67                                                                                                                                                                                                                                                                                                                                                                                       |                     |                               |                     |             |                        |                 |                              |                    |            |                      |                      |  |
| <b>Operating temperature*</b>       | Standard with fluorosilicone seals: -40 °C to 70 °C [-40 °F to 158 °F]<br>Optional with fluorocarbon seals: -12 °C to 70 °C [10 °F to 158 °F]                                                                                                                                                                                                                                                                   |                     |                               |                     |             |                        |                 |                              |                    |            |                      |                      |  |
| <b>ATEX/IEC Ex protection class</b> | II 2 GD, Ex d IIC T6 Gb, Ex tb IIIC T85°C Db                                                                                                                                                                                                                                                                                                                                                                    |                     |                               |                     |             |                        |                 |                              |                    |            |                      |                      |  |
| <b>UNSPSC code</b>                  | 302119                                                                                                                                                                                                                                                                                                                                                                                                          |                     |                               |                     |             |                        |                 |                              |                    |            |                      |                      |  |
| <b>UNSPSC commodity</b>             | 302119 Switches and controls and relays                                                                                                                                                                                                                                                                                                                                                                         |                     |                               |                     |             |                        |                 |                              |                    |            |                      |                      |  |

\* Reference operating head styles on page 6 for exceptions.

**Table 2. Agency Certifications**

|                                             |                | ATEX (CE) <sup>2</sup><br>Europe                                                    | CSA, UL, or<br>cULus <sup>3</sup><br>Canada, USA                                    | IEC Ex <sup>1</sup><br>International                                                | KOSHA<br>Korea                                                                       | NEPSI EX <sup>2</sup><br>China                                                        | INMETRO <sup>2</sup><br>Brazil                                                        | EAC <sup>4</sup><br>Russia<br>(formerly<br>GOST-R)                                    |
|---------------------------------------------|----------------|-------------------------------------------------------------------------------------|-------------------------------------------------------------------------------------|-------------------------------------------------------------------------------------|--------------------------------------------------------------------------------------|---------------------------------------------------------------------------------------|---------------------------------------------------------------------------------------|---------------------------------------------------------------------------------------|
|                                             |                |  |  |  |  |  |  |  |
|                                             | <b>Conduit</b> |                                                                                     |                                                                                     |                                                                                     |                                                                                      |                                                                                       |                                                                                       |                                                                                       |
| <b>BX Series<br/>(aluminum)</b>             | M20            | •                                                                                   |                                                                                     | •                                                                                   | •                                                                                    | •                                                                                     | •                                                                                     | •                                                                                     |
|                                             | NPT            | •                                                                                   | •                                                                                   | •                                                                                   | •                                                                                    | •                                                                                     | •                                                                                     | •                                                                                     |
| <b>BX2 Series<br/>(stainless<br/>steel)</b> | M20            | •                                                                                   | •                                                                                   | •                                                                                   | •                                                                                    | •                                                                                     | •                                                                                     | •                                                                                     |
|                                             | NPT            | •                                                                                   | •                                                                                   | •                                                                                   | •                                                                                    | •                                                                                     | •                                                                                     | •                                                                                     |

<sup>1</sup> ATEX & IEC Ex: II 2 GD; Ex d IIC T6 Gb; Ex tb IIIC T85°C Db; Ta -40 °C to 70 °C or -12 °C to 70 °C (dependent on seal material)

<sup>2</sup> NEPSI Ex: GYJ111016

<sup>3</sup> CSA, cUL, UL: NEMA 7 (Gas) Div 1&2, Class I, Groups B, C, & D; NEMA 9 (Dust) Div 1&2, Class II, Groups E, F, & G

<sup>4</sup> Russia Custom Union Certification per НАННО «ЦСВЭ» РОСС RU.0001.11ГБ05; 1Ex d IIC T6 Gb X, Ex tb IIIC T85°C Db

# MICRO SWITCH Hazardous Area Switches, BX | BX2 Series

## MICRO SWITCH BX and BX2 Series Electrical Ratings 10 A continuous carry; ac Volts; Pilot Duty: AC15, A600

| Electrical Rating | Circuitry    | Vac | Amps at 0.35 Power Factor Make | Amps at 0.35 Power Factor Break |
|-------------------|--------------|-----|--------------------------------|---------------------------------|
| AC15, A600        | SPDT<br>DPDT | 120 | 60                             | 6                               |
|                   |              | 240 | 30                             | 3                               |
|                   |              | 480 | 15                             | 1.5                             |
|                   |              | 600 | 12                             | 1.2                             |

## MICRO SWITCH BX and BX2 Series Electrical Ratings dc Volts; Pilot Duty: DC13, R300

| Electrical Rating | Circuitry    | Vdc | Make & Break Amps Inductive | Make & Break Amps Resistive |
|-------------------|--------------|-----|-----------------------------|-----------------------------|
| DC13, R300        | SPDT<br>DPDT | 120 | 0.25                        | 0.8                         |
|                   |              | 240 | 0.15                        | 0.4                         |

MICRO SWITCH BX and BX2 limit switches are capable of the following low voltage dc loads

| Circuitry  | Vdc | Amps Inductive | Amps Resistive |
|------------|-----|----------------|----------------|
| SPDT, DPDT | 24  | 10             | 10             |

## Switch Contact Styles, Double Break

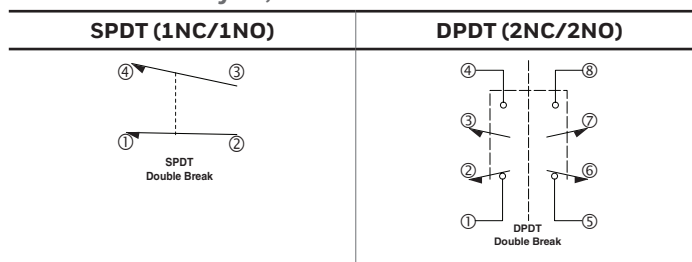

Center Neutral (SPDT each direction)  
Pole 1 operates CCW; Pole 2 operates CW

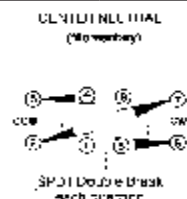

NOTE: Same polarity each pole

## Low Temperature Limits

For all MICRO SWITCH BX/BX2 styles, the upper temperature limit is 70 °C [158 °F], while the lower temperature limit is per the table below.

| Operating Head Styles                             | MICRO SWITCH BX/BX2       |                 |                                |               |
|---------------------------------------------------|---------------------------|-----------------|--------------------------------|---------------|
|                                                   | Standard (Fluorosilicone) |                 | Optional (Fluorocarbon Sealed) |               |
|                                                   | -40 °C [-40°F]            | -29 °C [-20 °F] | -12 °C [10°F]                  | -1 °C [30 °F] |
| BXA, BX2A - Side Rotary Momentary                 | •                         |                 | •                              |               |
| BXB - Top Rotary                                  |                           | •               |                                | •             |
| BXC, BX2C - Top Pin Plunger                       | •                         |                 | •                              |               |
| BXD, BX2D - Top Roller Plunger                    | •                         |                 | •                              |               |
| BXE, BX2E - Side Pin Plunger                      | •                         |                 | •                              |               |
| BXF, BX2F - Side Roller Plunger                   | •                         |                 | •                              |               |
| BXH, BX2H - Side Rotary, Low Pretravel and Torque |                           | •               |                                | •             |
| BXJ - Wobble Stick                                |                           | •               |                                | •             |
| BXK - Cat Whisker                                 |                           | •               |                                | •             |
| BXL, BX2L - Side Rotary, Sequential Operation     | •                         |                 | •                              |               |
| BXM, BX2M - Side Rotary, Center Neutral           | •                         |                 | •                              |               |
| BXN, BX2N - Side Rotary, Maintained               |                           | •               |                                | •             |
| BXP, BX2P - Side Rotary, Low Pretravel            | •                         |                 | •                              |               |
| BXR, BX2R - Side Rotary, Low Torque               |                           | •               |                                | •             |
| BXV - Top Adjustable Plunger                      | •                         |                 | •                              |               |
| BXW - Side Adjustable Plunger                     | •                         |                 | •                              |               |

# MICRO SWITCH Hazardous Area Switches, BX | BX2 Series

## Fluorocarbon Sealed Switches (optional)

Fluorocarbon (FC)-sealed switches have an FC o-ring between the threaded cover and body. Rotary types have an extra FC seal on the operating shaft, while plunger versions have FC boot seals. They are for use in applications where the environment includes fire-resistant synthetic fluids, synthetic fluids, water-based fluids, and petroleum-based fluids. The additional FC seals also promote longer operating life for rotary-actuated BX/BX2 switches in applications where the temperatures are normally elevated.

## MICRO SWITCH BX/BX2 Series Operating Heads\*

**SIDE ROTARY:** Heads may be positioned in any one of four positions, 90° increments. All are momentary action except maintained head (BXN/BX2N Series).

|                                                                                   |                                                                                                                                                             |
|-----------------------------------------------------------------------------------|-------------------------------------------------------------------------------------------------------------------------------------------------------------|
|  | <b>BXA/BX2A - Standard:</b> 60° minimum overtravel, 15° maximum pretravel, 5° (single pole) and 7° (double pole) maximum differential travel.               |
|                                                                                   | <b>BXR/BX2R - Low operating torque:</b> 60° minimum overtravel, 15° maximum pretravel, 0.19 Nm [1.7 in lb] maximum operating torque.                        |
|                                                                                   | <b>BXN/BX2N - Maintained contact:</b> Maintained on counterclockwise rotation and reset on clockwise rotation, and vice versa.                              |
|                                                                                   | <b>BXP/BX2P - Low differential:</b> 68° minimum overtravel, 9° maximum pretravel, 3° (single pole) and 4° (double pole) maximum differential travel.        |
|                                                                                   | <b>BXH/BX2H - Low torque, low differential travel:</b> 68° minimum overtravel. Features low operating torque and narrow differential travel.                |
|                                                                                   | <b>BXL/BX2L - Sequential operation:</b> 48° minimum overtravel. Delayed action between operation of two poles.                                              |
|                                                                                   | <b>BXM/BX2M - Center neutral:</b> 57° minimum overtravel. One pole operates on the clockwise rotation, and the other pole on the counterclockwise rotation. |

\***BX Series** epoxy-coated zinc heads are shown for illustration. **BX2 Series** heads are 316L stainless steel.

To order, insert the additional letter **C** in the appropriate places in the standard catalog listing, as shown below:

|                |                                              |
|----------------|----------------------------------------------|
| <b>BXA3K</b>   | standard, side-rotary switch                 |
| <b>BXAC3K</b>  | FC-sealed version of BXA3K                   |
| <b>BX2A3K</b>  | standard, stainless steel side-rotary switch |
| <b>BX2AC3K</b> | Fluorocarbon-sealed version of BX2A3K        |

**TOP ROTARY:** Available levers provide greater versatility. Heads may be positioned in any one of four positions, 90° increments. All are momentary action.

|                                                                                    |                                                                                                                                                                                     |
|------------------------------------------------------------------------------------|-------------------------------------------------------------------------------------------------------------------------------------------------------------------------------------|
|  | <b>BXB:</b> With 100° minimum overtravel. Various levers that fit side rotary shafts may be used on the top rotary shaft. Switch is suitable when increased overtravel is required. |
|------------------------------------------------------------------------------------|-------------------------------------------------------------------------------------------------------------------------------------------------------------------------------------|

**TOP PLUNGERS:** Available with 4,83 mm [0.19 in] minimum overtravel. Top pin plungers are offered in pin plunger, an adjustable plunger, and a roller plunger. All are momentary action.

|                                                                                      |                                                                                                                                                                                                                                                                                |
|--------------------------------------------------------------------------------------|--------------------------------------------------------------------------------------------------------------------------------------------------------------------------------------------------------------------------------------------------------------------------------|
|  | <b>BXC/BX2C - Top pin plunger:</b> A copper alloy plunger for in-line actuating motion. Oil-tight seals on plunger and between the operating head and housing keep out coolant, dust, and chips.                                                                               |
|  | <b>BXD/BX2D - Top roller plunger:</b> A copper alloy roller plunger is adjustable to 90° angles to accept cam or slide operation from any of two directions. Boot seal on the plunger.                                                                                         |
|  | <b>BXV - Adjustable top pin plunger:</b> A copper alloy adjustable plunger provides easy application and saves on installation time. The operating points of the switch can be adjusted from 52,8 mm to 59,3 mm [2.085 in to 2.335 in]. Seals are the same as the pin plunger. |

## MICRO SWITCH Hazardous Area Switches, BX | BX2 Series

### MICRO SWITCH BX/BX2 Series Operating Heads

**SIDE PLUNGERS:** Available with 4,83 mm [0.19 in] minimum overtravel. Side plungers are offered in pin plunger, adjustable pin plunger, and a roller plunger. All are momentary action.

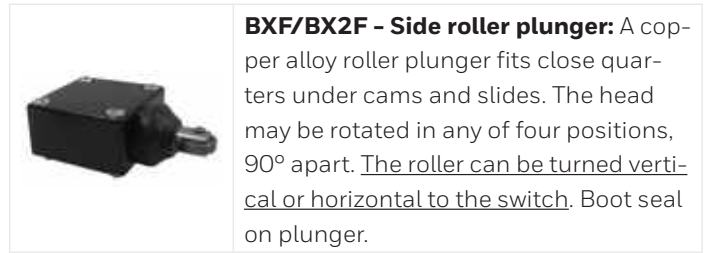
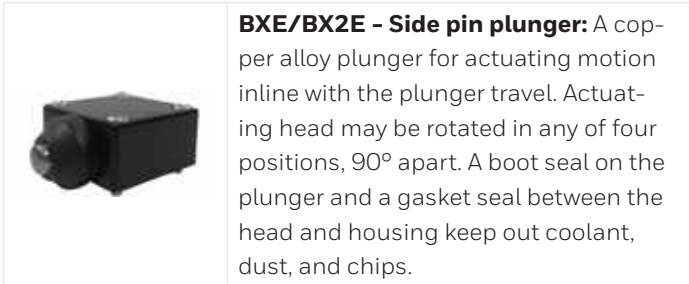

**WOBBLE LEVER ACTUATING HEADS:** Heads come with either a Delrin® plastic rod or copper alloy cat whisker. Any movement of the lever (except pull) will actuate the switch.



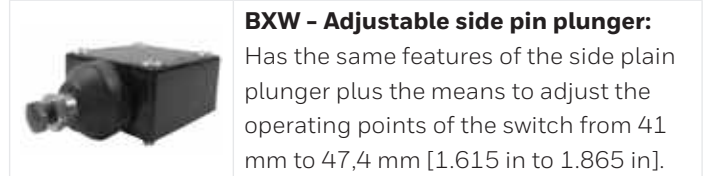

**BXK - Plastic rod:** Recommended where possible scratching or marring by the actuator is to be avoided.

**BXJ - Cat whisker:** Copper alloy actuator designed for low operating force applications.



# MICRO SWITCH Hazardous Area Switches, BX | BX2 Series

## SIDE ROTARY • MICRO SWITCH BX/BX2 SERIES ORDER GUIDE/RECOMMENDED LISTINGS

| <b>BXA /BX2A • Standard CW/CCW Momentary</b>                                                                                                                                                                                                                                                                                                                                                                                                                                                                                                                                                                                                                                                                                                                                                                                                                                              | <b>Housing Material</b> | <b>Contacts (snap-action)</b> | <b>Contact Material</b> | <b>Conduit</b> | <b>Listing</b> |
|-------------------------------------------------------------------------------------------------------------------------------------------------------------------------------------------------------------------------------------------------------------------------------------------------------------------------------------------------------------------------------------------------------------------------------------------------------------------------------------------------------------------------------------------------------------------------------------------------------------------------------------------------------------------------------------------------------------------------------------------------------------------------------------------------------------------------------------------------------------------------------------------|-------------------------|-------------------------------|-------------------------|----------------|----------------|
|  <p>15°</p> <p>1-2 <input type="checkbox"/> <input type="checkbox"/> →<br/>3-4 <input type="checkbox"/> <input type="checkbox"/> →<br/>3-4 <input type="checkbox"/> <input type="checkbox"/> ←<br/>1-2 <input type="checkbox"/> <input type="checkbox"/> ←</p> <p>0° 10° 75°</p> <p>Pretravel • 15° max.<br/>Diff. travel (SPDT) • 5° max.<br/>Diff. travel (DPDT) • 7° max.<br/>Overtravel • 60° min.<br/>Oper. torque • 0,45 Nm [4 in-lb] max.<br/>*Oper. temp • -40 °C to 70 °C [-40 °F to 158 °F]</p> <p>15°</p> <p>1-2/5-6 <input type="checkbox"/> <input type="checkbox"/> →<br/>3-4/7-8 <input type="checkbox"/> <input type="checkbox"/> →<br/>3-4/7-8 <input type="checkbox"/> <input type="checkbox"/> ←<br/>1-2/5-6 <input type="checkbox"/> <input type="checkbox"/> ←</p> <p>0° 8° 75°</p> | Aluminum                | 1NC-1NO                       | Silver                  | 0.5-14 NPT     | <b>BXA3K</b>   |
|                                                                                                                                                                                                                                                                                                                                                                                                                                                                                                                                                                                                                                                                                                                                                                                                                                                                                           | Aluminum                | 1NC-1NO                       | Gold plate              | 0.5-14 NPT     | <b>BXA3E</b>   |
|                                                                                                                                                                                                                                                                                                                                                                                                                                                                                                                                                                                                                                                                                                                                                                                                                                                                                           | Aluminum                | 1NC-1NO                       | Silver                  | 0.75-14 NPT    | <b>BXA4K</b>   |
|                                                                                                                                                                                                                                                                                                                                                                                                                                                                                                                                                                                                                                                                                                                                                                                                                                                                                           | Aluminum                | 1NC-1NO                       | Silver                  | 20 mm          | <b>BX4A3K</b>  |
|                                                                                                                                                                                                                                                                                                                                                                                                                                                                                                                                                                                                                                                                                                                                                                                                                                                                                           | Aluminum                | 1NC-1NO                       | Gold plate              | 20 mm          | <b>BX4A3E</b>  |
|                                                                                                                                                                                                                                                                                                                                                                                                                                                                                                                                                                                                                                                                                                                                                                                                                                                                                           | Stainless Steel         | 1NC-1NO                       | Silver                  | 0.5-14 NPT     | <b>BX2A3K</b>  |
|                                                                                                                                                                                                                                                                                                                                                                                                                                                                                                                                                                                                                                                                                                                                                                                                                                                                                           | Stainless Steel         | 1NC-1NO                       | Silver                  | 20 mm          | <b>BX24A3K</b> |
|                                                                                                                                                                                                                                                                                                                                                                                                                                                                                                                                                                                                                                                                                                                                                                                                                                                                                           | Aluminum                | 2NC-2NO                       | Silver                  | 0.75-14 NPT    | <b>BXA4L</b>   |
|                                                                                                                                                                                                                                                                                                                                                                                                                                                                                                                                                                                                                                                                                                                                                                                                                                                                                           | Aluminum                | 2NC-2NO                       | Silver                  | 20 mm          | <b>BX4A4L</b>  |
|                                                                                                                                                                                                                                                                                                                                                                                                                                                                                                                                                                                                                                                                                                                                                                                                                                                                                           | Aluminum                | 2NC-2NO                       | Gold plate              | 0.5-14 NPT     | <b>BXA7S</b>   |
|                                                                                                                                                                                                                                                                                                                                                                                                                                                                                                                                                                                                                                                                                                                                                                                                                                                                                           | Aluminum                | 2NC-2NO                       | Gold plate              | 0.75-14 NPT    | <b>BXA4S</b>   |
|                                                                                                                                                                                                                                                                                                                                                                                                                                                                                                                                                                                                                                                                                                                                                                                                                                                                                           | Stainless Steel         | 2NC-2NO                       | Silver                  | 0.75-14 NPT    | <b>BX2A4L</b>  |
| <b>BXP /BX2P • Low Differential CW/CCW Momentary</b>                                                                                                                                                                                                                                                                                                                                                                                                                                                                                                                                                                                                                                                                                                                                                                                                                                      | <b>Housing Material</b> | <b>Contacts (snap-action)</b> | <b>Contact Material</b> | <b>Conduit</b> | <b>Listing</b> |
|  <p>9°</p> <p>1-2 <input type="checkbox"/> <input type="checkbox"/> →<br/>3-4 <input type="checkbox"/> <input type="checkbox"/> →<br/>3-4 <input type="checkbox"/> <input type="checkbox"/> ←<br/>1-2 <input type="checkbox"/> <input type="checkbox"/> ←</p> <p>0° 6° 75°</p> <p>Pretravel • 9° max.<br/>Diff. travel (SPDT) • 3° max.<br/>Diff. travel (DPDT) • 4° max.<br/>Overtravel • 66° min.<br/>Oper. torque • 0,45 Nm [4 in-lb] max.<br/>*Oper. temp • -40 °C to 70 °C [-40 °F to 158 °F]</p> <p>9°</p> <p>1-2/5-6 <input type="checkbox"/> <input type="checkbox"/> →<br/>3-4/7-8 <input type="checkbox"/> <input type="checkbox"/> →<br/>3-4/7-8 <input type="checkbox"/> <input type="checkbox"/> ←<br/>1-2/5-6 <input type="checkbox"/> <input type="checkbox"/> ←</p> <p>0° 5° 75°</p>   | Aluminum                | 1NC-1NO                       | Silver                  | 0.5-14 NPT     | <b>BXP3K</b>   |
|                                                                                                                                                                                                                                                                                                                                                                                                                                                                                                                                                                                                                                                                                                                                                                                                                                                                                           | Aluminum                | 2NC-2NO                       | Silver                  | 0.75-14 NPT    | <b>BXP4L</b>   |
|                                                                                                                                                                                                                                                                                                                                                                                                                                                                                                                                                                                                                                                                                                                                                                                                                                                                                           | Stainless Steel         | 2NC-2NO                       | Silver                  | 0.75-14 NPT    | <b>BX2P4L</b>  |
|                                                                                                                                                                                                                                                                                                                                                                                                                                                                                                                                                                                                                                                                                                                                                                                                                                                                                           | Stainless Steel         | 2NC-2NO                       | Silver                  | 20 mm          | <b>BX24P4L</b> |

Contact closed ; Contact open

Actuating head is factory set for CW and CCW actuation. Easily field adjusted for CW or CCW per instructions included with switch.



NOTE: Same polarity each pole.

\* Operating temperature range for standard fluorosilicone sealed switch. For optional fluorocarbon sealed switch, see temperature table, page 8. To order a fluorocarbon sealed version, insert the additional letter "C" in the standard catalog listing, as follows. The BXA3K limit switch is changed to a BXA**C**3K limit switch.



# MICRO SWITCH Hazardous Area Switches, BX | BX2 Series

## SIDE ROTARY • MICRO SWITCH BX/BX2 SERIES ORDER GUIDE/RECOMMENDED LISTINGS

| BX <sub>R</sub> • Low Torque,<br>CW and CCW Momentary                                                                                                                                                                                                                                                                                                                                                                                                                                                                                                                                                                                                                                                                                                                                                                                                                                              | Housing Material | Contacts<br>(snap-action) | Contact Material | Conduit     | Listing      |
|----------------------------------------------------------------------------------------------------------------------------------------------------------------------------------------------------------------------------------------------------------------------------------------------------------------------------------------------------------------------------------------------------------------------------------------------------------------------------------------------------------------------------------------------------------------------------------------------------------------------------------------------------------------------------------------------------------------------------------------------------------------------------------------------------------------------------------------------------------------------------------------------------|------------------|---------------------------|------------------|-------------|--------------|
|  <p>15°</p> <p>1-2 <input type="checkbox"/> <input type="checkbox"/> →<br/>3-4 <input type="checkbox"/> <input type="checkbox"/> →<br/>3-4 <input type="checkbox"/> <input type="checkbox"/> ←<br/>1-2 <input type="checkbox"/> <input type="checkbox"/> ←</p> <p>0° 10° 75°</p> <p>Pretravel • 15° max.<br/>Diff. travel (SPDT) • 5° max.<br/>Diff. travel (DPDT) • 7° max.<br/>Overtravel • 60° min.<br/>Oper. torque • 0,19 Nm [1.7 in-lb] max.<br/>*Oper. temp • -29 °C to 70 °C [-20 °F to 158 °F]</p> <p>15°</p> <p>1-2/5-6 <input type="checkbox"/> <input type="checkbox"/> →<br/>3-4/7-8 <input type="checkbox"/> <input type="checkbox"/> →<br/>3-4/7-8 <input type="checkbox"/> <input type="checkbox"/> ←<br/>1-2/5-6 <input type="checkbox"/> <input type="checkbox"/> ←</p> <p>0° 8° 75°</p>        | Aluminum         | 1NC-1NO                   | Silver           | 0.5-14 NPT  | <b>BXR3K</b> |
|                                                                                                                                                                                                                                                                                                                                                                                                                                                                                                                                                                                                                                                                                                                                                                                                                                                                                                    | Aluminum         | 1NC-1NO                   | Gold plate       | 0.5-14 NPT  | <b>BXR3E</b> |
|                                                                                                                                                                                                                                                                                                                                                                                                                                                                                                                                                                                                                                                                                                                                                                                                                                                                                                    | Aluminum         | 2NC-2NO                   | Silver           | 0.75-14 NPT | <b>BXR4L</b> |
|                                                                                                                                                                                                                                                                                                                                                                                                                                                                                                                                                                                                                                                                                                                                                                                                                                                                                                    | Aluminum         | 2NC-2NO                   | Gold plate       | 0.75-14 NPT | <b>BXR4S</b> |
| BX <sub>H</sub> • Low Differential, Low Torque,<br>CW and CCW Momentary                                                                                                                                                                                                                                                                                                                                                                                                                                                                                                                                                                                                                                                                                                                                                                                                                            | Housing Material | Contacts<br>(snap-action) | Contact Material | Conduit     | Listing      |
|  <p>9°</p> <p>1-2 <input type="checkbox"/> <input type="checkbox"/> →<br/>3-4 <input type="checkbox"/> <input type="checkbox"/> →<br/>3-4 <input type="checkbox"/> <input type="checkbox"/> ←<br/>1-2 <input type="checkbox"/> <input type="checkbox"/> ←</p> <p>0° 6° 75°</p> <p>Pretravel • 9° max.<br/>Diff. travel (SPDT) • 3° max.<br/>Diff. travel (DPDT) • 4° max.<br/>Overtravel • 66° min.<br/>Oper. torque • 0,19 Nm [1.7 in-lb] max.<br/>*Oper. temp • -29 °C to 70 °C [-20 °F to 158 °F]</p> <p>9°</p> <p>1-2/5-6 <input type="checkbox"/> <input type="checkbox"/> →<br/>3-4/7-8 <input type="checkbox"/> <input type="checkbox"/> →<br/>3-4/7-8 <input type="checkbox"/> <input type="checkbox"/> ←<br/>1-2/5-6 <input type="checkbox"/> <input type="checkbox"/> ←</p> <p>0° 5° 75°</p>           | Aluminum         | 2NC-2NO                   | Silver           | 0.75-14 NPT | <b>BXH4L</b> |
| BX <sub>B</sub> • Top Rotary,<br>CW and CCW Momentary                                                                                                                                                                                                                                                                                                                                                                                                                                                                                                                                                                                                                                                                                                                                                                                                                                              | Housing Material | Contacts<br>(snap-action) | Contact Material | Conduit     | Listing      |
|  <p>35°</p> <p>1-2 <input type="checkbox"/> <input type="checkbox"/> →<br/>3-4 <input type="checkbox"/> <input type="checkbox"/> →<br/>3-4 <input type="checkbox"/> <input type="checkbox"/> ←<br/>1-2 <input type="checkbox"/> <input type="checkbox"/> ←</p> <p>0° 27° 135°</p> <p>Pretravel • 35° max.<br/>Diff. travel (SPDT) • 8° max.<br/>Diff. travel (DPDT) • 12° max.<br/>Overtravel • 100° min.<br/>Oper. torque • 0,28 Nm [2.5 in-lb] max.<br/>*Oper. temp • -29 °C to 70 °C [-20 °F to 158 °F]</p> <p>35°</p> <p>1-2/5-6 <input type="checkbox"/> <input type="checkbox"/> →<br/>3-4/7-8 <input type="checkbox"/> <input type="checkbox"/> →<br/>3-4/7-8 <input type="checkbox"/> <input type="checkbox"/> ←<br/>1-2/5-6 <input type="checkbox"/> <input type="checkbox"/> ←</p> <p>0° 23° 135°</p> | Aluminum         | 1NC-1NO                   | Silver           | 0.5-14 NPT  | <b>BXB3K</b> |

Contact closed ; Contact open











Actuating head is factory set for CW and CCW actuation. Easily field adjusted for CW or CCW per instructions included with switch.

NOTE: Same polarity each pole.

\* Operating temperature range for standard fluorosilicone sealed switch. For optional fluorocarbon sealed switch, see temperature table, page 8. To order a fluorocarbon sealed version, insert the additional letter "C" in the standard catalog listing, as follows. The BXA3K limit switch is changed to a BXA**C**3K limit switch.

# MICRO SWITCH Hazardous Area Switches, BX | BX2 Series

## SIDE ROTARY • MICRO SWITCH BX/BX2 SERIES ORDER GUIDE/RECOMMENDED LISTINGS

| <b>BXN • Maintained, Two Position<br/>CCW (trip), CW (Reset)</b>                                                                                                                                                                                                                                                                                                                                                                                                                                                                                                                                                                                                                                                                                                                                                                                                                                                                                                                         | <b>Housing Material</b> | <b>Contacts<br/>(snap-action)</b> | <b>Contact Material</b> | <b>Conduit</b> | <b>Listing</b> |
|------------------------------------------------------------------------------------------------------------------------------------------------------------------------------------------------------------------------------------------------------------------------------------------------------------------------------------------------------------------------------------------------------------------------------------------------------------------------------------------------------------------------------------------------------------------------------------------------------------------------------------------------------------------------------------------------------------------------------------------------------------------------------------------------------------------------------------------------------------------------------------------------------------------------------------------------------------------------------------------|-------------------------|-----------------------------------|-------------------------|----------------|----------------|
|  <p>           1-2  →<br/>           3-4  ←<br/>           1-2         </p> <p>           0° 25° 65° 85°         </p> <p>           Pretravel • 65° max.<br/>           Diff. travel • 40° max.<br/>           Overtravel • 20° min.<br/>           Oper. torque • 0,45 Nm [4 in-lb] max.<br/>           *Oper. temp • -29 °C to 70 °C [-20 °F to 158 °F]         </p> <p>           1-2/5-6  →<br/>           3-4/7-8  ←<br/>           3-4/7-8<br/>           1-2/5-6         </p> <p>           0° 25° 65° 85°         </p>                                      | Aluminum                | 1NC-1NO                           | Silver                  | 0.5-14 NPT     | <b>BXN3K</b>   |
|                                                                                                                                                                                                                                                                                                                                                                                                                                                                                                                                                                                                                                                                                                                                                                                                                                                                                                                                                                                          | Aluminum                | 1NC-1NO                           | Silver                  | 20 mm          | <b>BX4N3K</b>  |
|                                                                                                                                                                                                                                                                                                                                                                                                                                                                                                                                                                                                                                                                                                                                                                                                                                                                                                                                                                                          | Aluminum                | 2NC-2NO                           | Silver                  | 0.75-14 NPT    | <b>BXN4L</b>   |
|                                                                                                                                                                                                                                                                                                                                                                                                                                                                                                                                                                                                                                                                                                                                                                                                                                                                                                                                                                                          | Aluminum                | 2NC-2NO                           | Silver                  | 20 mm          | <b>BX4N4L</b>  |
| <b>BXM • Center Neutral,<br/>CW and CCW Momentary</b>                                                                                                                                                                                                                                                                                                                                                                                                                                                                                                                                                                                                                                                                                                                                                                                                                                                                                                                                    | <b>Housing Material</b> | <b>Contacts<br/>(snap-action)</b> | <b>Contact Material</b> | <b>Conduit</b> | <b>Listing</b> |
|  <p>           Pretravel • 18° max.<br/>           Diff. travel • 10° max.<br/>           Overtravel • 57° min.<br/>           Oper. torque • 0,45 Nm [4 in-lb] max.<br/>           *Oper. temp • -40 °C to 70 °C [-40 °F to 158 °F]         </p> <p>           75° 18° 0° 75°<br/>           1-2  ←<br/>           3-4  →<br/>           3-4<br/>           1-2<br/>           CCW 8° CW         </p> <p>           75° 0° 18° 75°<br/>           5-6  →<br/>           7-8  ←<br/>           7-8<br/>           5-6<br/>           CCW 8° CW         </p> | Aluminum                | 2NC-2NO                           | Silver                  | 0.75-14 NPT    | <b>BXM4N</b>   |
|                                                                                                                                                                                                                                                                                                                                                                                                                                                                                                                                                                                                                                                                                                                                                                                                                                                                                                                                                                                          | Aluminum                | 2NC-2NO                           | Silver                  | 20 mm          | <b>BX4M4N</b>  |

Contact closed ■; Contact open □







NOTE: Same polarity each pole.

\* Operating temperature range for standard fluorosilicone sealed switch. For optional fluorocarbon sealed switch, see temperature table, page 8. To order a fluorocarbon sealed version, insert the additional letter "C" in the standard catalog listing, as follows. The BXA3K limit switch is changed to a BXA**C**3K limit switch.

## MICRO SWITCH Hazardous Area Switches, BX | BX2 Series

**Table 3. Common levers for use with MICRO SWITCH BX Rotary Switches\***

Levers for use with side-rotary-actuated switches are available in a wide choice of sizes and materials. The most common listings are shown below. Rollers may be on either side of the lever to best match the external actuating mechanism.





|                                                                                                                  |                                                                                     |                                                                                                                   |                                                                                     |                                                                                                              |                                                                                      |                                                                                      |
|------------------------------------------------------------------------------------------------------------------|-------------------------------------------------------------------------------------|-------------------------------------------------------------------------------------------------------------------|-------------------------------------------------------------------------------------|--------------------------------------------------------------------------------------------------------------|--------------------------------------------------------------------------------------|--------------------------------------------------------------------------------------|
|                                 |                                                                                     |                                  |                                                                                     |                           |                                                                                      |                                                                                      |
| <b>Fixed lever, nylon roller</b><br><b>LSZ51A</b> - front mount roller<br><b>LSZ51C</b> - back mount roller      |                                                                                     | <b>Short fixed lever, nylon roller</b><br><b>LSZ59A</b> - front mount roller<br><b>LSZ59C</b> - back mount roller |                                                                                     | <b>Offset lever, nylon roller</b><br><b>LSZ55A</b> - back mount roller<br><b>LSZ55C</b> - front mount roller |                                                                                      |                                                                                      |
|                                 |                                                                                     |                                  |                                                                                     |                                                                                                              |                                                                                      |                                                                                      |
| <b>One-way lever, nylon roller</b><br><b>LSZ60A</b> - front mount roller                                         |                                                                                     | <b>Yoke lever, nylon rollers</b><br><b>LSZ53A</b> - front/back mount rollers                                      |                                                                                     |                                                                                                              |                                                                                      |                                                                                      |
|                               |  |                                |  |                          |  |  |
| <b>Adjustable lever, nylon roller</b><br><b>LSZ52A</b> - back mount roller<br><b>LSZ52C</b> - front mount roller | <b>LSZ52J</b><br>adjustable lever, nylon roller<br>25,4 mm [1 in]                   | <b>LSZ52K</b><br>adjustable lever, nylon roller<br>38,1 [1.5 in]                                                  | <b>LSZ54M</b><br>aluminum rod<br>140 mm [5.5 in]                                    | <b>LSZ61</b><br>loop<br>152 mm [6 in]                                                                        | <b>LSZ67CA**</b><br>Plastic conveyor roller                                          | <b>LSZ68</b><br>rod with spring<br>305 mm [12 in]                                    |







\* Non-sparking rollers and actuators must be used in hazardous areas.

\*\* May require orientation of switch and lever to enable gravity to help restore switch's free position.

# MICRO SWITCH Hazardous Area Switches, BX | BX2 Series

Table 4. BX/BX2 Series Lever Order Guide

|                                                                                     | Catalog Listing                                                                    | Material                                         | Roller Dia. mm [in] | Roller Width mm [in] | Roller Mounting |
|-------------------------------------------------------------------------------------|------------------------------------------------------------------------------------|--------------------------------------------------|---------------------|----------------------|-----------------|
|    | <b>Fixed 38,1 [1.5] inch radius</b>                                                |                                                  |                     |                      |                 |
|                                                                                     | LSZ51                                                                              | Rollerless                                       | n/a                 | n/a                  | n/a             |
|                                                                                     | LSZ51A                                                                             | Nylon                                            | 19 [0.75]           | 6,35 [0.25]          | Front           |
|                                                                                     | LSZ51C                                                                             | Nylon                                            | 19 [0.75]           | 6,35 [0.25]          | Back            |
|                                                                                     | LSZ51F                                                                             | Nylon                                            | 25,4 [1.0]          | 12,7 [0.50]          | Front           |
|                                                                                     | LSZ51G                                                                             | Nylon                                            | 38,1 [1.5]          | 6,35 [0.25]          | Front           |
|                                                                                     | LSZ51J                                                                             | Nylon                                            | 25,4 [1.0]          | 12,7 [0.50]          | Back            |
|                                                                                     | LSZ51M                                                                             | Nylon                                            | 19 [0.75]           | 31,7 [1.25]          | Back            |
|                                                                                     | LSZ51P                                                                             | Nylon                                            | 19 [0.75]           | 12,7 [0.50]          | Front           |
|                                                                                     | LSZ251A (sst)                                                                      | Nylon                                            | 19 [0.75]           | 6,35 [0.25]          | Front           |
|                                                                                     | LSZ251C (sst)                                                                      | Nylon                                            | 19 [0.75]           | 6,35 [0.25]          | Back            |
|                                                                                     | LSZ251E (sst)                                                                      | Copper alloy                                     | 19 [0.75]           | 6,35 [0.25]          | Front           |
|                                                                                     | LSZ251F (sst)                                                                      | Copper alloy                                     | 19 [0.75]           | 6,35 [0.25]          | Back            |
|                                                                                     |  | <b>Adjustable 38,1 [1.5] in to 3.5 in radius</b> |                     |                      |                 |
| LSZ52                                                                               |                                                                                    | Rollerless                                       | n/a                 | n/a                  | n/a             |
| LSZ52A                                                                              |                                                                                    | Nylon                                            | 19 [0.75]           | 6,35 [0.25]          | Back            |
| LSZ52C                                                                              |                                                                                    | Nylon                                            | 19 [0.75]           | 6,35 [0.25]          | Front           |
| LSZ52E                                                                              |                                                                                    | Nylon                                            | 19 [0.75]           | 33,0 [1.30]          | Front           |
| LSZ52J                                                                              |                                                                                    | Nylon                                            | 25,4 [1.0]          | 12,7 [0.50]          | Front           |
| LSZ52K                                                                              |                                                                                    | Nylon                                            | 38,1 [1.5]          | 6,35 [0.25]          | Front           |
| LSZ52M                                                                              |                                                                                    | Nylon                                            | 50,8 [2.0]          | 6,35 [0.25]          | Front           |
| LSZ52N                                                                              |                                                                                    | Nylon                                            | 19 [0.75]           | 12,7 [0.50]          | Front           |
| LSZ252A (sst)                                                                       |                                                                                    | Nylon                                            | 19 [0.75]           | 6,35 [0.25]          | Front           |
| LSZ252C (sst)                                                                       |                                                                                    | Nylon                                            | 19 [0.75]           | 6,35 [0.25]          | Back            |
| LSZ252E (sst)                                                                       |                                                                                    | Copper alloy                                     | 19 [0.75]           | 6,35 [0.25]          | Front           |
| LSZ252F (sst)                                                                       |                                                                                    | Copper alloy                                     | 19 [0.75]           | 6,35 [0.25]          | Back            |
|  |                                                                                    | <b>Yoke - 38,1 [1.5] in radius</b>               |                     |                      |                 |
|                                                                                     | LSZ53A                                                                             | Nylon                                            | 19 [0.75]           | 6,35 [0.25]          | Front/Back      |
|                                                                                     | LSZ53E                                                                             | Nylon                                            | 19 [0.75]           | 6,35 [0.25]          | Back/Front      |
|                                                                                     | LSZ53M                                                                             | Nylon                                            | 19 [0.75]           | 31,7 [1.25]          | Back/Front      |
| LSZ53S                                                                              | Nylon                                                                              | 19 [0.75]                                        | 6,35 [0.25]         | Back/Back            |                 |
|  | <b>Rod</b>                                                                         |                                                  |                     |                      |                 |
|                                                                                     | LSZ54                                                                              | Hub only                                         | n/a                 | n/a                  | n/a             |
|                                                                                     | LSZ54M                                                                             | Alum, 140 mm [5.5 in]                            | Ø 3,2 [Ø 0.125]     | n/a                  | n/a             |
|                                                                                     | LSZ54N                                                                             | Stainless, 330 mm [13 in]                        | Ø 3,2 [Ø 0.125]     | n/a                  | n/a             |
|                                                                                     | LSZ54P                                                                             | Plastic rod, 305 mm [12 in]                      | Ø 6,85 [Ø 0.27]     | n/a                  | n/a             |
| LSZ54W                                                                              | Plastic rod, 183 mm [7.2 in]                                                       | Ø 6,85 [Ø 0.27]                                  | n/a                 | n/a                  |                 |





|                                                                                      | Catalog Listing                             | Material                     | Roller Dia. mm [in]           | Roller Width mm [in] | Roller Mounting  |
|--------------------------------------------------------------------------------------|---------------------------------------------|------------------------------|-------------------------------|----------------------|------------------|
|     | <b>Offset - 38,1 [1.5] in radius</b>        |                              |                               |                      |                  |
|                                                                                      | LSZ55                                       | Rollerless                   | n/a                           | n/a                  | n/a              |
|                                                                                      | LSZ55A                                      | Nylon                        | 19 [0.75]                     | 6,35 [0.25]          | Back             |
|                                                                                      | LSZ55C                                      | Nylon                        | 19 [0.75]                     | 6,35 [0.25]          | Front            |
|                                                                                      | LSZ55E                                      | Nylon                        | 19 [0.75]                     | 12,7 [0.50]          | Front            |
| LSZ55K                                                                               | Nylon                                       | 38,1 [1.5]                   | 6,35 [0.25]                   | Front                |                  |
|     | <b>Short fixed - 1.3 in radius</b>          |                              |                               |                      |                  |
|                                                                                      | LSZ59A                                      | Nylon                        | 19 [0.75]                     | 6,35 [0.25]          | Front            |
| LSZ59C                                                                               | Nylon                                       | 19 [0.75]                    | 6,35 [0.25]                   | Back                 |                  |
|     | <b>One-way roller lever</b>                 |                              |                               |                      |                  |
| LSZ60A                                                                               | Nylon                                       | 19 [0.75]                    | 6,35 [0.25]                   | Front                |                  |
|    | <b>Flexible loop</b>                        |                              |                               |                      |                  |
|                                                                                      | LSZ61                                       | Ø 4,8 [Ø 0.19] Nylatron      | 152 mm [6 in] flexible loop   |                      |                  |
|                                                                                      | LSZ618                                      | Ø 4,8 [Ø 0.19] Nylatron      | 241 mm [9.5 in] flexible loop |                      |                  |
| LSZ54                                                                                | Hub only                                    | n/a                          | n/a                           | n/a                  |                  |
|   | <b>Spring rod</b>                           |                              |                               |                      |                  |
|                                                                                      | LSZ68                                       | Delrin rod, 305 mm [12 in]   | Ø 6,35 [0.25]                 | n/a                  | n/a              |
|                                                                                      | LSZ617                                      | Delrin rod, 406 mm [16 in]   | Ø 6,35 [0.25]                 | n/a                  | n/a              |
| LSZ686                                                                               | Delrin rod, 152 mm [6 in]                   | Ø 6,35 [0.25]                | n/a                           | n/a                  |                  |
|   | <b>Rubber roller levers</b>                 |                              |                               |                      |                  |
|                                                                                      | LSZ51Y                                      | 38,1 [1.5] radius (standard) | Rubber                        | 50 [2.0]             | 12,7 [0.5] front |
|                                                                                      | LSZ55Y                                      | 38,1 [1.5] radius (offset)   | Rubber                        | 50 [2.0]             | 12,7 [0.5] front |
| LSZ52Y                                                                               | 38,1 to 89 [1.5 to 3.5] radius (adjustable) | Rubber                       | 50 [2.0]                      | 12,7 [0.5] front     |                  |
|  | <b>Plastic roller levers</b>                |                              |                               |                      |                  |
| LSZ67AA (conveyor)*                                                                  | Plastic                                     | 38,1 [1.5]                   | 96,5 [3.8]                    | n/a                  |                  |

\* May require orientation of switch and lever to enable gravity to help restore switch to free position.

# MICRO SWITCH Hazardous Area Switches, BX | BX2 Series

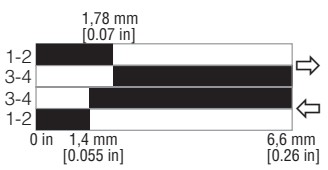
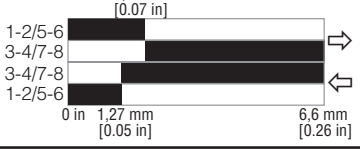
## TOP PLUNGER • MICRO SWITCH BX/BX2 SERIES ORDER GUIDE/RECOMMENDED LISTINGS

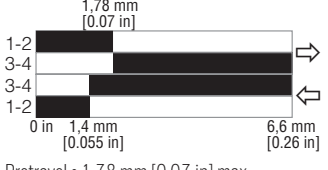
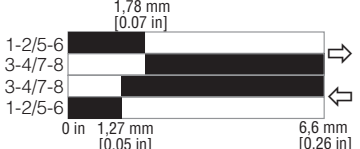
All top plungers are momentary action.

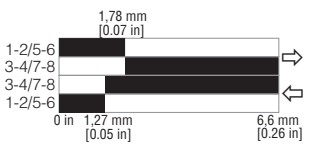
| <b>BXC /BX2C • Top Pin Plunger</b>                                                                                                                                                                                                                                                                                                                                                                                                                                                                                                                                                                                                                                                                                                                                              |                                                                          | <b>Housing Material</b> | <b>Contacts (snap-action)</b> | <b>Contact Material</b>       | <b>Conduit</b>          | <b>Listing</b> |
|---------------------------------------------------------------------------------------------------------------------------------------------------------------------------------------------------------------------------------------------------------------------------------------------------------------------------------------------------------------------------------------------------------------------------------------------------------------------------------------------------------------------------------------------------------------------------------------------------------------------------------------------------------------------------------------------------------------------------------------------------------------------------------|--------------------------------------------------------------------------|-------------------------|-------------------------------|-------------------------------|-------------------------|----------------|
|  <p>1-2  →<br/>←</p> <p>1,78 mm [0.07 in]<br/>0 in 1,4 mm [0.055 in] 6,6 mm [0.26 in]</p> <p>Pretravel • 1,78 mm [0.07 in] max.<br/>Diff. travel (SPDT) • 0,38 mm [0.015 in] max.<br/>Diff travel (DPDT) • 0,51 mm [0.020 in] max.<br/>Overtravel • 4,83 mm [0.190 in] min.<br/>Oper. point • 58,5 ±0,76 mm [2.305 ±0.030 in]<br/>Oper. force • 17,8 N [4 lb] max.<br/>*Oper. temp • -40 °C to 70 °C [-40 °F to 158 °F]</p> <p>1-2/5-6  →<br/>←</p> <p>1,78 mm [0.07 in]<br/>0 in 1,27 mm [0.05 in] 6,6 mm [0.26 in]</p>     | Aluminum                                                                 | 1NC-1NO                 | Silver                        | 0.5-14 NPT                    | <b>BXC3K</b>            |                |
|                                                                                                                                                                                                                                                                                                                                                                                                                                                                                                                                                                                                                                                                                                                                                                                 | Aluminum                                                                 | 1NC-1NO                 | Silver                        | 0.75-14 NPT                   | <b>BXC4K</b>            |                |
|                                                                                                                                                                                                                                                                                                                                                                                                                                                                                                                                                                                                                                                                                                                                                                                 | Aluminum                                                                 | 1NC-1NO                 | Silver                        | 20 mm                         | <b>BX4C3K</b>           |                |
|                                                                                                                                                                                                                                                                                                                                                                                                                                                                                                                                                                                                                                                                                                                                                                                 | Aluminum                                                                 | 1NC-1NO                 | Gold plate                    | 20mm                          | <b>BX4C3E</b>           |                |
|                                                                                                                                                                                                                                                                                                                                                                                                                                                                                                                                                                                                                                                                                                                                                                                 | Aluminum                                                                 | 2NC-2NO                 | Silver                        | 0.75-14 NPT                   | <b>BXC4L</b>            |                |
|                                                                                                                                                                                                                                                                                                                                                                                                                                                                                                                                                                                                                                                                                                                                                                                 | Aluminum                                                                 | 2NC-2NO                 | Silver                        | 20 mm                         | <b>BX4C4L</b>           |                |
|                                                                                                                                                                                                                                                                                                                                                                                                                                                                                                                                                                                                                                                                                                                                                                                 | Aluminum                                                                 | 2NC-2NO                 | Gold plate                    | 20 mm                         | <b>BX4C4S</b>           |                |
|                                                                                                                                                                                                                                                                                                                                                                                                                                                                                                                                                                                                                                                                                                                                                                                 | Stainless steel                                                          | 2NC-2NO                 | Silver                        | 0.75-14 NPT                   | <b>BX2C4L</b>           |                |
|                                                                                                                                                                                                                                                                                                                                                                                                                                                                                                                                                                                                                                                                                                                                                                                 | Stainless steel                                                          | 2NC-2NO                 | Silver                        | 20 mm                         | <b>BX24C4L</b>          |                |
|                                                                                                                                                                                                                                                                                                                                                                                                                                                                                                                                                                                                                                                                                                                                                                                 | <b>BXD /BX2D • Top Roller Plunger (can be rotated at 90° increments)</b> |                         | <b>Housing Material</b>       | <b>Contacts (snap-action)</b> | <b>Contact Material</b> | <b>Conduit</b> |
|  <p>1-2  →<br/>←</p> <p>1,78 mm [0.07 in]<br/>0 in 1,4 mm [0.055 in] 6,6 mm [0.26 in]</p> <p>Pretravel • 1,78 mm [0.07 in] max.<br/>Diff. travel (SPDT) • 0,38 mm [0.015 in] max.<br/>Diff travel (DPDT) • 0,51 mm [0.020 in] max.<br/>Overtravel • 4,83 mm [0.190 in] min.<br/>Oper. point • 68,6 ±1,02 mm [2.70 ±0.040 in]<br/>Oper. force • 17,8 N [4 lb] max.<br/>*Oper. temp • -40 °C to 70 °C [-40 °F to 158 °F]</p> <p>1-2/5-6  →<br/>←</p> <p>1,78 mm [0.07 in]<br/>0 in 1,27 mm [0.05 in] 6,6 mm [0.26 in]</p> | Aluminum                                                                 | 1NC-1NO                 | Silver                        | 0.5-14 NPT                    | <b>BXD3K</b>            |                |
|                                                                                                                                                                                                                                                                                                                                                                                                                                                                                                                                                                                                                                                                                                                                                                                 | Aluminum                                                                 | 1NC-1NO                 | Silver                        | 20 mm                         | <b>BX4D3K</b>           |                |
|                                                                                                                                                                                                                                                                                                                                                                                                                                                                                                                                                                                                                                                                                                                                                                                 | Aluminum                                                                 | 1NC-1NO                 | Gold plate                    | 20 mm                         | <b>BX4D3E</b>           |                |
|                                                                                                                                                                                                                                                                                                                                                                                                                                                                                                                                                                                                                                                                                                                                                                                 | Aluminum                                                                 | 2NC-2NO                 | Silver                        | 0.75-14 NPT                   | <b>BXD4L</b>            |                |
|                                                                                                                                                                                                                                                                                                                                                                                                                                                                                                                                                                                                                                                                                                                                                                                 | Aluminum                                                                 | 2NC-2NO                 | Silver                        | 20 mm                         | <b>BX4D4L</b>           |                |
|                                                                                                                                                                                                                                                                                                                                                                                                                                                                                                                                                                                                                                                                                                                                                                                 | Aluminum                                                                 | 2NC-2NO                 | Gold plate                    | 20 mm                         | <b>BX4D4S</b>           |                |
|                                                                                                                                                                                                                                                                                                                                                                                                                                                                                                                                                                                                                                                                                                                                                                                 | Stainless steel                                                          | 2NC-2NO                 | Silver                        | 0.75-14 NPT                   | <b>BX2D4L</b>           |                |
|                                                                                                                                                                                                                                                                                                                                                                                                                                                                                                                                                                                                                                                                                                                                                                                 | Stainless steel                                                          | 2NC-2NO                 | Silver                        | 20 mm                         | <b>BX24D4L</b>          |                |
|                                                                                                                                                                                                                                                                                                                                                                                                                                                                                                                                                                                                                                                                                                                                                                                 | <b>BXV • Top Adjustable Plunger</b>                                      |                         | <b>Housing Material</b>       | <b>Contacts (snap-action)</b> | <b>Contact Material</b> | <b>Conduit</b> |
|  <p>Pretravel • 1,78 mm [0.07 in] max.<br/>Diff. travel (SPDT) • 0,38 mm [0.015 in] max.<br/>Diff travel (DPDT) • 0,51 mm [0.020 in] max.<br/>Overtravel • 4,83 mm [0.190 in] min.<br/>Oper. point • 65,66 [2.585] min; 72,01 [2.835] max.<br/>Oper. force • 17,8 N [4 lb] max.<br/>*Oper. temp • -40 °C to 70 °C [-40 °F to 158 °F]</p> <p>1-2/5-6  →<br/>←</p> <p>1,78 mm [0.07 in]<br/>0 in 1,27 mm [0.05 in] 6,6 mm [0.26 in]</p>                                                                                                                                                                     | Aluminum                                                                 | 2NC-2NO                 | Silver                        | 0.75-14 NPT                   | <b>BXV4L</b>            |                |

Contact closed ■; Contact open □



















NOTE: Same polarity each pole.

\*Operating temperature range for standard fluorosilicone sealed switch. For optional fluorocarbon sealed switch, see temperature table, page 8. To order a fluorocarbon sealed version, insert the additional letter "C" in the standard catalog listing, as follows. The BXA3K limit switch is changed to a BXAC3K limit switch.

# MICRO SWITCH Hazardous Area Switches, BX | BX2 Series

## SIDE PLUNGER • MICRO SWITCH BX/BX2 SERIES ORDER GUIDE/RECOMMENDED LISTINGS

All side plungers are momentary action.

| <b>BXE /BX2E • Side Pin Plunger</b>                                                                                                                                                                                                                                                                                                                                                                                                                                                                                                                                                                                                                                                                                                                                                                                                                                                                                                                                                                                                                                                                                                                                                                                                                                                                                                                                                                                                                                                                                                                                                                                                                                                                                                                   |                 | <b>Housing Material</b> | <b>Contacts (snap-action)</b> | <b>Contact Material</b> | <b>Conduit</b> | <b>Listing</b> |
|-------------------------------------------------------------------------------------------------------------------------------------------------------------------------------------------------------------------------------------------------------------------------------------------------------------------------------------------------------------------------------------------------------------------------------------------------------------------------------------------------------------------------------------------------------------------------------------------------------------------------------------------------------------------------------------------------------------------------------------------------------------------------------------------------------------------------------------------------------------------------------------------------------------------------------------------------------------------------------------------------------------------------------------------------------------------------------------------------------------------------------------------------------------------------------------------------------------------------------------------------------------------------------------------------------------------------------------------------------------------------------------------------------------------------------------------------------------------------------------------------------------------------------------------------------------------------------------------------------------------------------------------------------------------------------------------------------------------------------------------------------|-----------------|-------------------------|-------------------------------|-------------------------|----------------|----------------|
|  <p>                     2,54 mm [0.10 in]<br/>                     1-2  →<br/>                     3-4  ←<br/>                     3-4  →<br/>                     1-2  ←<br/>                     0 in 1,4 mm [0.055 in] 7,36 mm [0.29 in]                 </p> <p>                     Pretravel • 2,54 mm [0.10 in] max.<br/>                     Diff. travel • 1,14 mm [0.045 in] max.<br/>                     Overtravel • 4,83 mm [0.190 in] min.<br/>                     Oper. point • 33,02 ±0,76 mm [1.30 ±0.030 in]<br/>                     Oper. force • 26,79 N [6 lb] max.<br/>                     *Oper. temp • -40 °C to 70 °C [-40 °F to 158 °F]                 </p> <p>                     2,54 mm [0.10 in]<br/>                     1-2/5-6  →<br/>                     3-4/7-8  ←<br/>                     3-4/7-8  →<br/>                     1-2/5-6  ←<br/>                     0 in 1,4 mm [0.055 in] 7,36 mm [0.29 in]                 </p>                 | Aluminum        | 1NC-1NO                 | Silver                        | 0.5-14 NPT              | <b>BXE3K</b>   |                |
|                                                                                                                                                                                                                                                                                                                                                                                                                                                                                                                                                                                                                                                                                                                                                                                                                                                                                                                                                                                                                                                                                                                                                                                                                                                                                                                                                                                                                                                                                                                                                                                                                                                                                                                                                       | Aluminum        | 1NC-1NO                 | Gold plate                    | 0.5-14 NPT              | <b>BXE3E</b>   |                |
|                                                                                                                                                                                                                                                                                                                                                                                                                                                                                                                                                                                                                                                                                                                                                                                                                                                                                                                                                                                                                                                                                                                                                                                                                                                                                                                                                                                                                                                                                                                                                                                                                                                                                                                                                       | Stainless steel | 1NC-1NO                 | Silver                        | 0.5-14 NPT              | <b>BX2E3K</b>  |                |
|                                                                                                                                                                                                                                                                                                                                                                                                                                                                                                                                                                                                                                                                                                                                                                                                                                                                                                                                                                                                                                                                                                                                                                                                                                                                                                                                                                                                                                                                                                                                                                                                                                                                                                                                                       | Stainless steel | 1NC-1NO                 | Gold plate                    | 0.5-14 NPT              | <b>BX2E3E</b>  |                |
|                                                                                                                                                                                                                                                                                                                                                                                                                                                                                                                                                                                                                                                                                                                                                                                                                                                                                                                                                                                                                                                                                                                                                                                                                                                                                                                                                                                                                                                                                                                                                                                                                                                                                                                                                       | Aluminum        | 2NC-2NO                 | Silver                        | 0.75-14 NPT             | <b>BXE4L</b>   |                |
|                                                                                                                                                                                                                                                                                                                                                                                                                                                                                                                                                                                                                                                                                                                                                                                                                                                                                                                                                                                                                                                                                                                                                                                                                                                                                                                                                                                                                                                                                                                                                                                                                                                                                                                                                       | Aluminum        | 2NC-2NO                 | Gold plate                    | 0.75-14 NPT             | <b>BXE4S</b>   |                |
| <b>BXF /BX2F • Side Roller Plunger</b>                                                                                                                                                                                                                                                                                                                                                                                                                                                                                                                                                                                                                                                                                                                                                                                                                                                                                                                                                                                                                                                                                                                                                                                                                                                                                                                                                                                                                                                                                                                                                                                                                                                                                                                |                 | <b>Housing Material</b> | <b>Contacts (snap-action)</b> | <b>Contact Material</b> | <b>Conduit</b> | <b>Listing</b> |
|  <p>                     2,54 mm [0.10 in]<br/>                     1-2  →<br/>                     3-4  ←<br/>                     3-4  →<br/>                     1-2  ←<br/>                     0 in 1,4 mm [0.055 in] 7,36 mm [0.29 in]                 </p> <p>                     Pretravel • 2,54 mm [0.10 in] max.<br/>                     Diff. travel • 1,14 mm [0.045 in] max.<br/>                     Overtravel • 4,83 mm [0.190 in] min.<br/>                     Oper. point • 44,07 ±1,02 mm [1.735 in ±0.040]<br/>                     Oper. force • 26,79 N [6 lb] max.<br/>                     *Oper. temp • -40 °C to 70 °C [-40 °F to 158 °F]                 </p> <p>                     2,54 mm [0.10 in]<br/>                     1-2/5-6  →<br/>                     3-4/7-8  ←<br/>                     3-4/7-8  →<br/>                     1-2/5-6  ←<br/>                     0 in 1,4 mm [0.055 in] 7,36 mm [0.29 in]                 </p> | Aluminum        | 1NC-1NO                 | Silver                        | 0.5-14 NPT              | <b>BXF3K</b>   |                |
|                                                                                                                                                                                                                                                                                                                                                                                                                                                                                                                                                                                                                                                                                                                                                                                                                                                                                                                                                                                                                                                                                                                                                                                                                                                                                                                                                                                                                                                                                                                                                                                                                                                                                                                                                       | Aluminum        | 1NC-1NO                 | Gold plate                    | 0.5-14 NPT              | <b>BXF3E</b>   |                |
|                                                                                                                                                                                                                                                                                                                                                                                                                                                                                                                                                                                                                                                                                                                                                                                                                                                                                                                                                                                                                                                                                                                                                                                                                                                                                                                                                                                                                                                                                                                                                                                                                                                                                                                                                       | Stainless steel | 1NC-1NO                 | Silver                        | 0.5-14 NPT              | <b>BX2F3K</b>  |                |
|                                                                                                                                                                                                                                                                                                                                                                                                                                                                                                                                                                                                                                                                                                                                                                                                                                                                                                                                                                                                                                                                                                                                                                                                                                                                                                                                                                                                                                                                                                                                                                                                                                                                                                                                                       | Stainless steel | 1NC-1NO                 | Gold plate                    | 0.5-14 NPT              | <b>BX2F3E</b>  |                |
|                                                                                                                                                                                                                                                                                                                                                                                                                                                                                                                                                                                                                                                                                                                                                                                                                                                                                                                                                                                                                                                                                                                                                                                                                                                                                                                                                                                                                                                                                                                                                                                                                                                                                                                                                       | Aluminum        | 2NC-2NO                 | Silver                        | 0.75-14 NPT             | <b>BXF4L</b>   |                |
|                                                                                                                                                                                                                                                                                                                                                                                                                                                                                                                                                                                                                                                                                                                                                                                                                                                                                                                                                                                                                                                                                                                                                                                                                                                                                                                                                                                                                                                                                                                                                                                                                                                                                                                                                       | Aluminum        | 2NC-2NO                 | Gold plate                    | 0.75-14 NPT             | <b>BXF4S</b>   |                |



Contact closed ■; Contact open □

NOTE: Same polarity each pole.

\* Operating temperature range for standard fluorosilicone sealed switch. For optional fluorocarbon sealed switch, see temperature table, page 8. To order a fluorocarbon sealed version, insert the additional letter "C" in the standard catalog listing, as follows. The BXA3K limit switch is changed to a BXA**C**3K limit switch.

# MICRO SWITCH Hazardous Area Switches, BX | BX2 Series

## WOBBLE • MICRO SWITCH BX/BX2 SERIES ORDER GUIDE/RECOMMENDED LISTINGS

| <b>BXJ • Wobble, Plastic Rod (7A Actuator)</b>                                                                                                                                                                                                                                                                                                                                                           |          | <b>Housing Material</b> | <b>Contacts (snap-action)</b> | <b>Contact Material</b> | <b>Conduit</b>   | <b>Listing</b> |
|----------------------------------------------------------------------------------------------------------------------------------------------------------------------------------------------------------------------------------------------------------------------------------------------------------------------------------------------------------------------------------------------------------|----------|-------------------------|-------------------------------|-------------------------|------------------|----------------|
|  <p>12°</p> <p>1-2<br/>3-4<br/>3-4<br/>1-2</p> <p>0° 8° 40°</p> <p>Actuator length • 152 mm [6 in]<br/>Pretravel • 25,4 mm [1.0 in] max.<br/>Oper. force • 2,8 N [10 oz] max.<br/>*Oper. temp • -29 °C to 70 °C [-20 °F to 158 °F]</p> <p>12°</p> <p>1-2/5-6<br/>3-4/7-8<br/>3-4/7-8<br/>1-2/5-6</p> <p>0° 8° 40°</p>   | Aluminum | 1NC-1NO                 | Silver                        | 0.5-14 NPT              | <b>BXJ3K-7A</b>  |                |
|                                                                                                                                                                                                                                                                                                                                                                                                          | Aluminum | 1NC-1NO                 | Silver                        | 20 mm                   | <b>BX4J3K-7A</b> |                |
|                                                                                                                                                                                                                                                                                                                                                                                                          | Aluminum | 1NC-1NO                 | Gold plate                    | 0.5-14 NPT              | <b>BXJ3E-7A</b>  |                |
|                                                                                                                                                                                                                                                                                                                                                                                                          | Aluminum | 2NC-2NO                 | Silver                        | 0.75-14 NPT             | <b>BXJ4L-7A</b>  |                |
|                                                                                                                                                                                                                                                                                                                                                                                                          | Aluminum | 2NC-2NO                 | Silver                        | 20 mm                   | <b>BX4J4L-7A</b> |                |
| <b>BXK • Wobble, Cat Whisker (8A Actuator)</b>                                                                                                                                                                                                                                                                                                                                                           |          | <b>Housing Material</b> | <b>Contacts (snap-action)</b> | <b>Contact Material</b> | <b>Conduit</b>   | <b>Listing</b> |
|  <p>25°</p> <p>1-2<br/>3-4<br/>3-4<br/>1-2</p> <p>0° 15° 50°</p> <p>Actuator length • 152 mm [6 in]<br/>Pretravel • 50,8 mm [2.0 in] max.<br/>Oper. force • 1,4 N [5 oz] max.<br/>*Oper. temp • -29 °C to 70 °C [-20 °F to 158 °F]</p> <p>25°</p> <p>1-2/5-6<br/>3-4/7-8<br/>3-4/7-8<br/>1-2/5-6</p> <p>0° 15° 50°</p> | Aluminum | 1NC-1NO                 | Silver                        | 0.5-14 NPT              | <b>BXK3K-8A</b>  |                |
|                                                                                                                                                                                                                                                                                                                                                                                                          | Aluminum | 1NC-1NO                 | Gold plate                    | 0.5-14 NPT              | <b>BXK3E-8A</b>  |                |
|                                                                                                                                                                                                                                                                                                                                                                                                          | Aluminum | 2NC-2NO                 | Silver                        | 0.75-14 NPT             | <b>BXK4L-8A</b>  |                |
|                                                                                                                                                                                                                                                                                                                                                                                                          | Aluminum | 2NC-2NO                 | Silver                        | 20 mm                   | <b>BX4K4L-8A</b> |                |

Contact closed ■; Contact open □

NOTE: Same polarity each pole.

\* Operating temperature range for standard fluorosilicone sealed switch. For optional fluorocarbon sealed switch, see temperature table, page 8. To order a fluorocarbon sealed version, insert the additional letter "C" in the standard catalog listing, as follows. The BXA3K limit switch is changed to a BXA3C3K limit switch.

## MICRO SWITCH Hazardous Area Switches, BX | BX2 Series

### REPLACEMENT CONTACT BLOCKS

| Circuitry                   | Replacement Contact Block |
|-----------------------------|---------------------------|
| Single pole                 | LSXZ3K                    |
| Double pole                 | LSXZ3L                    |
| Sequence or central neutral | LSXZ3M                    |

### REPLACEMENT HEADS for STANDARD

#### BX Switches

| Switch Type | Catalog Listing/Operating Head Only |
|-------------|-------------------------------------|
| BXA         | LSZ1AB                              |
| BXB         | LSZ1BB                              |
| BXC         | LSXZ1CB                             |
| BXD         | LSXZ1DB                             |
| BXE         | LSXZ1EB                             |
| BXF         | LSXZ1FB                             |
| BXH         | LSZ1HB                              |
| BXJ         | LSZ1JBGA                            |
| BXK         | LSXZ1KBHA                           |
| BXL         | LSZ1LB                              |
| BXM         | LSZ1MB                              |
| BXP         | LSZ1PB                              |
| BXR         | LSZ1RB                              |
| BXV         | LSXZ1VB                             |
| BXW         | LSXZ1WB                             |

### ASSEMBLY MODIFICATIONS

Momentary action rotary switches can be furnished in other than the normal assembled conditions. To specify modifications, add the numbers shown below to the catalog listings. Modification number suffixes are:

- 1** Clockwise actuation only
- 2** Counterclockwise actuation only
- 3** Shaft to right of switch front
- 4** Shaft to left of switch front
- 5** Shaft to back of switch

#### For example,

Catalog listing BXA3K**23** is a BXA3K switch adjusted for counterclockwise actuation only. The operating shaft is to the right side of the switch when viewing it from the front (label side).

No lever.

### PLUNGER ASSEMBLY MODIFICATIONS

Add the following modification numbers to the catalog listing in the plunger switch:

- 3** Side plunger to right of switch front
- 4** Side plunger to left of switch front
- 5** Side plunger to back of switch
- 6** Roller on top plungers perpendicular to mounting surface
- 8** Roller on side plungers in vertical position

#### For example,

Catalog listing BXF3K**3** is a BXF3K switch with the side roller plunger to the right side.



# MICRO SWITCH Hazardous Area Switches, BX | BX2 Series

Figure 3. MICRO SWITCH BX Series Side Rotary Product Dimensions • mm [in]

Side Rotary – Head Codes: A, H, L, M, N, P, Q, AND R

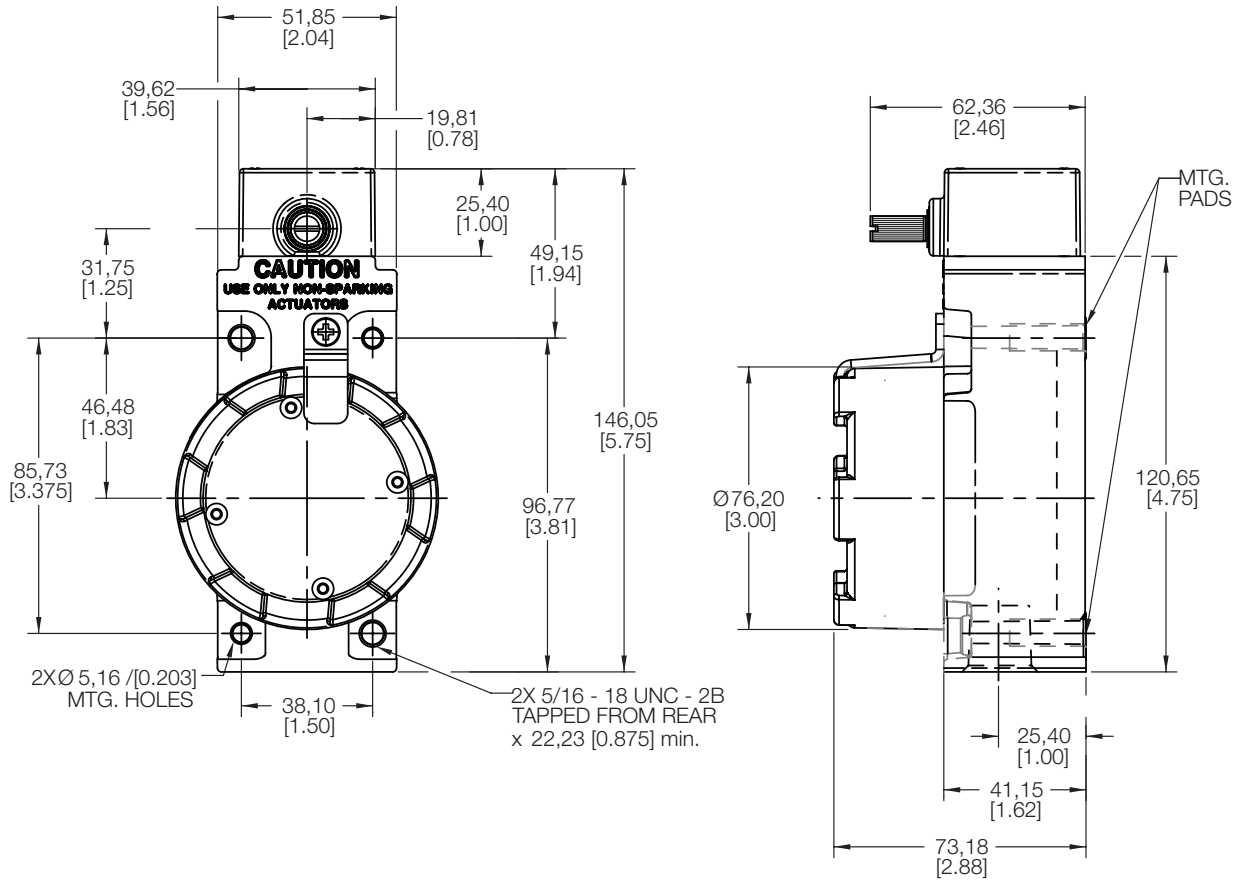
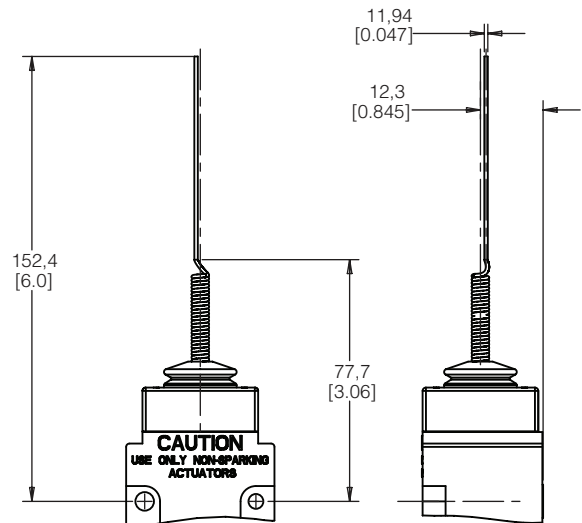
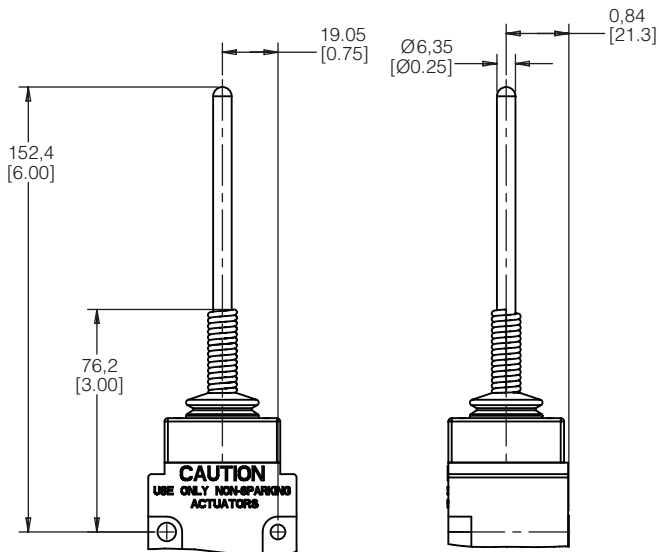

Figure 4. MICRO SWITCH BX Series Wobble Stick, Head Code J • mm [in]

Figure 5. MICRO SWITCH BX SERIES Cat Whisker Wobble, Head Code K • mm [in]



# MICRO SWITCH Hazardous Area Switches, BX | BX2 Series

**Figure 6. MICRO SWITCH BX Series Top Rotary, Head Code B • mm [in]**

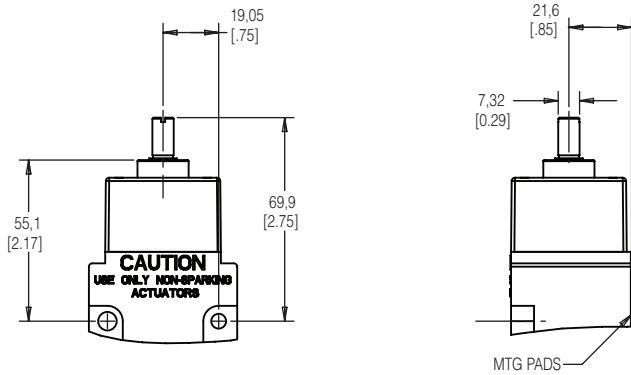

**Figure 7. MICRO SWITCH BX Series Top Pin Plunger, Head Code C • mm [in]**

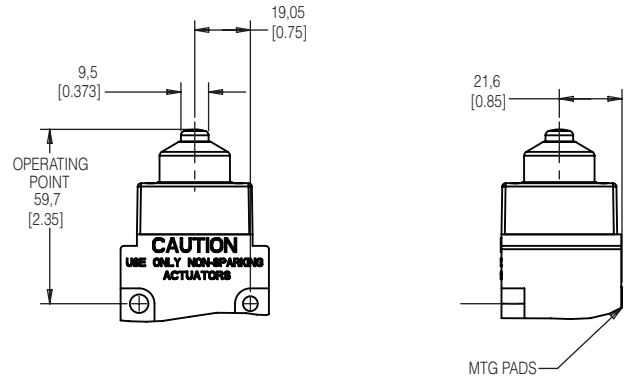

**Figure 8. MICRO SWITCH BX Series Top Roller Plunger, Head Code D • mm [in]**

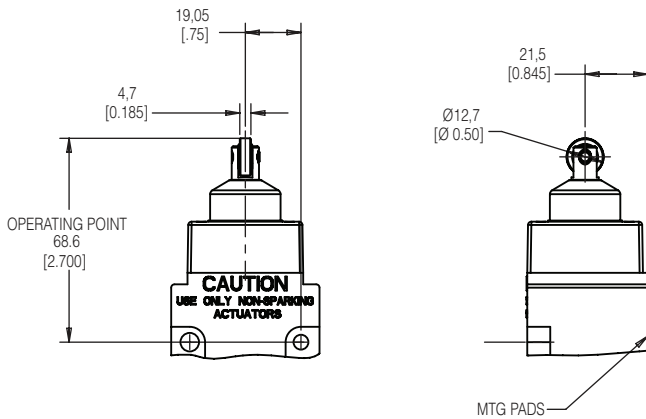

**Figure 9. MICRO SWITCH BX Series Side Plunger, Head Code E • mm [in]**

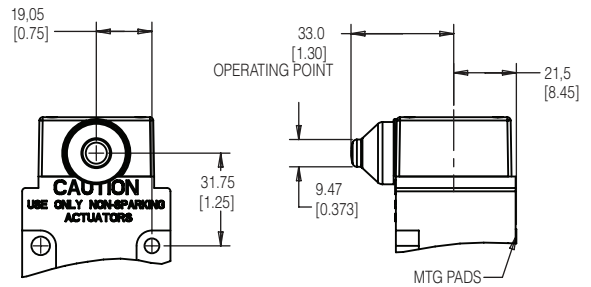

**Figure 11. MICRO SWITCH BX Series Adjustable Top Pin Plunger, Head Code V • mm [in]**

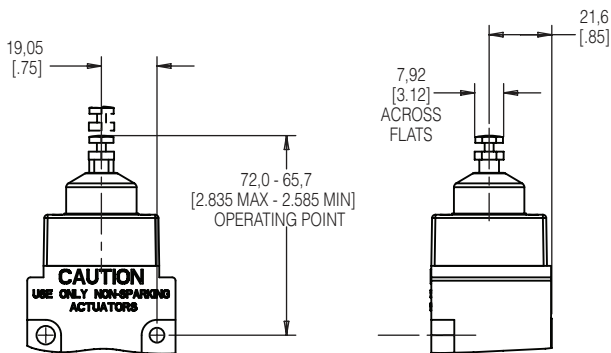

**Figure 10. MICRO SWITCH BX Series Side Roller Plunger, Head Code F • mm [in]**

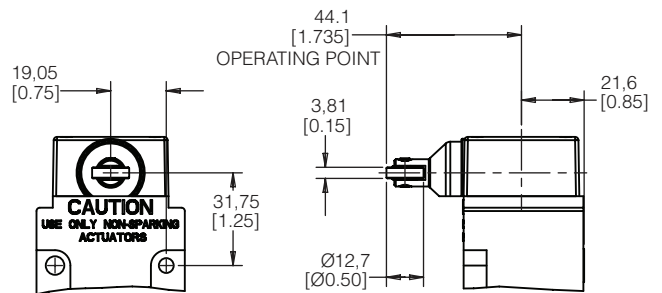

**Figure 12. MICRO SWITCH BX Series Adjustable Side Pin Plunger, Head Code W • mm [in]**

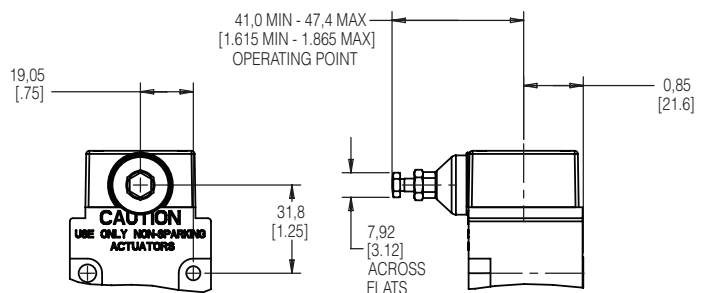

# MICRO SWITCH Hazardous Area Switches, BX | BX2 Series

Figure 13. MICRO SWITCH BX2 Series Side Rotary Product Dimensions • mm [in]  
Side Rotary - Head Codes: A, P, AND R

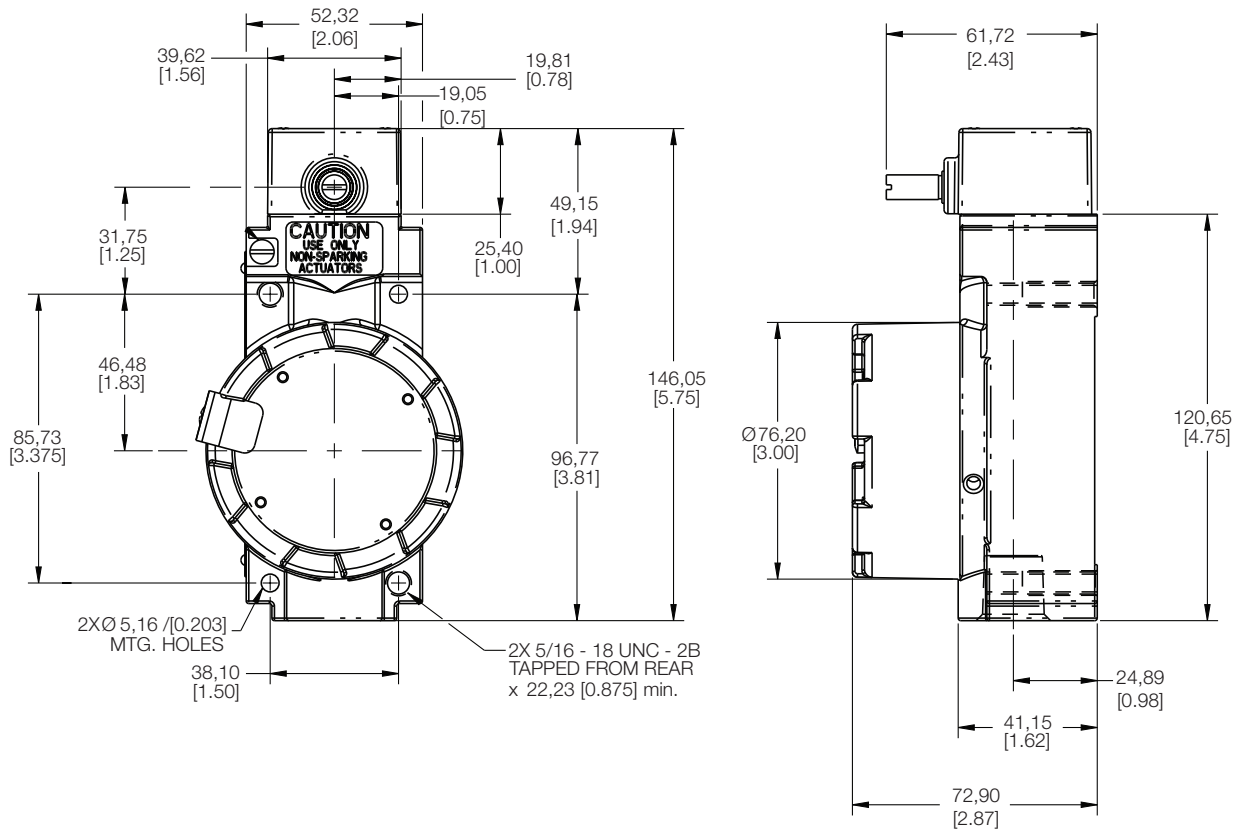
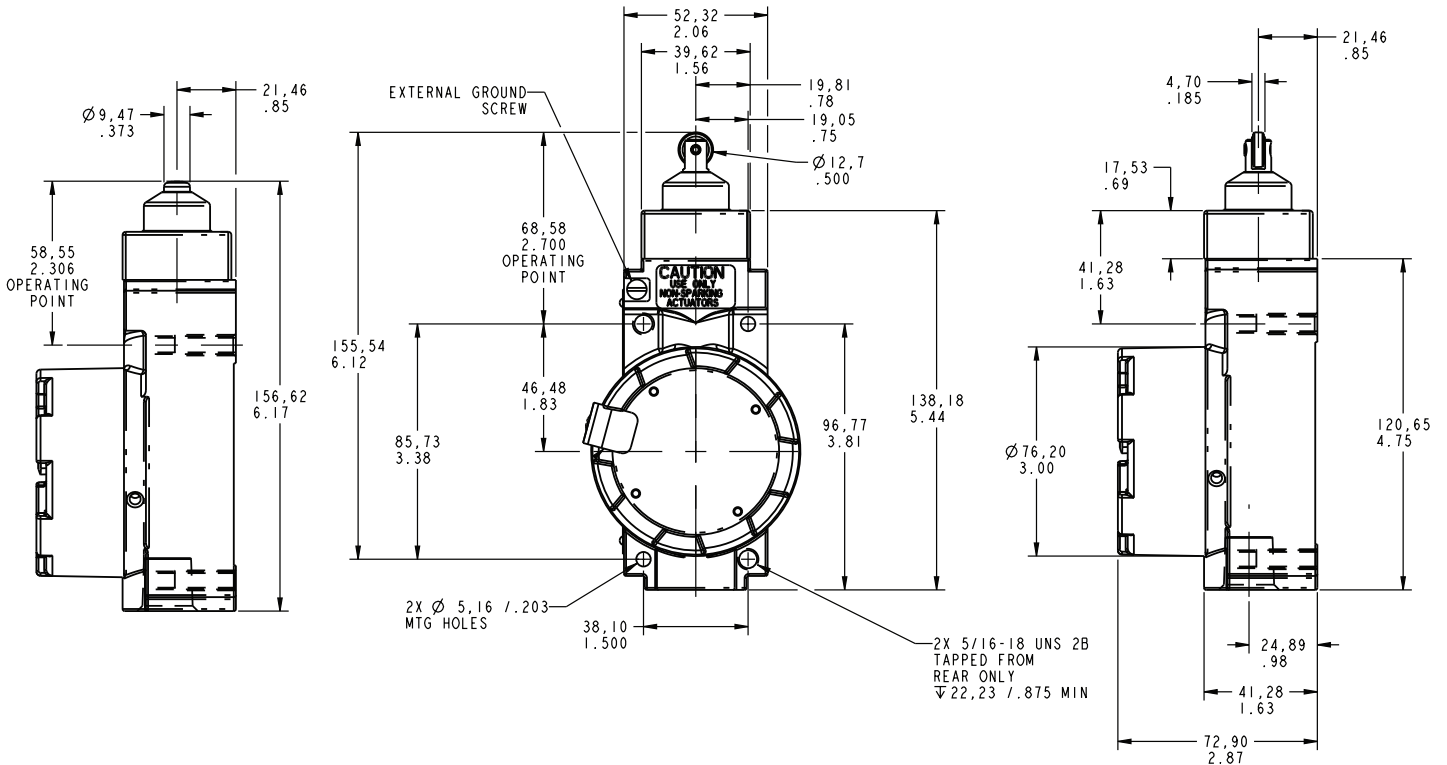
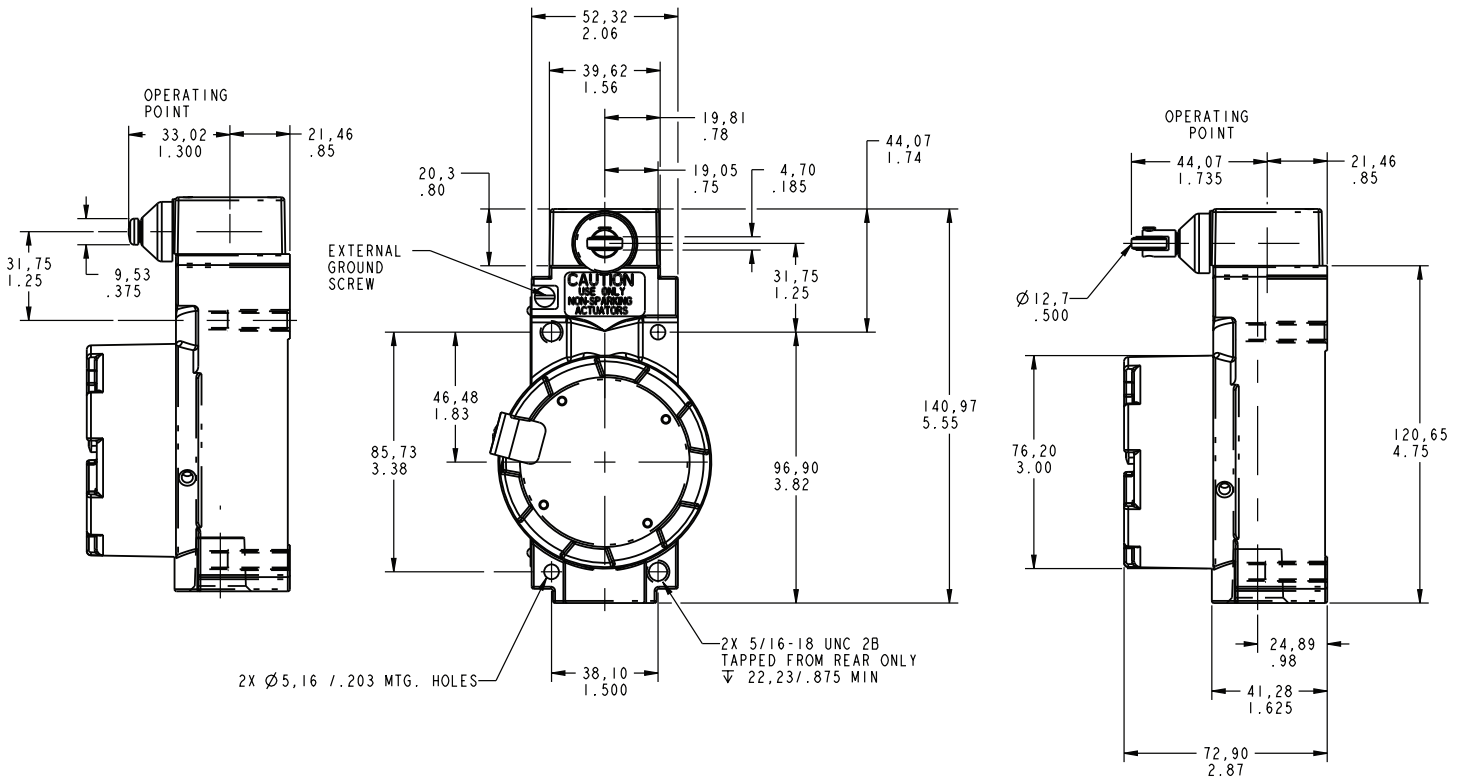

Figure 14. MICRO SWITCH BX2 Series Top Plunger Product Dimensions • mm [in]  
Top Plunger - Head Codes: C and D



# MICRO SWITCH Hazardous Area Switches, BX | BX2 Series

Figure 15. MICRO SWITCH BX2 Series Side Plunger Product Dimensions • mm [in]  
Side Plunger – Head Codes: E and F



## ADDITIONAL INFORMATION

The following associated literature is available on the Honeywell web site at [sensing.honeywell.com](http://sensing.honeywell.com):

- Product installation instructions
- Product range guide
- Hazardous area product brochure
- Product application-specific information
  - Application Note: Gas Recovery Unit and Other O&G Drilling Applications
  - Application Note: Pipeline Pig Passage Detection/Indicator Applications
  - Application Note: Electronic Sensors and Electromechanical Switches in Valves and Flow Meters
  - Application Note: Sensors and Switches Used in Valve Actuators and Valve Positioners
  - Application Note: Sensors and Switches for Industrial Manual Process Valves
  - Sensors and Switches in Oil Rig Applications

### Find out more

Honeywell serves its customers through a worldwide network of sales offices and distributors.

For application assistance, current specifications, pricing or name of the nearest Authorized Distributor, contact your local sales office.

To learn more about Honeywell's sensing and switching products, call **+1-815-235-6847** or

**1-800-537-6945,**

visit **[sensing.honeywell.com](http://sensing.honeywell.com)**, or

e-mail inquiries to

**[info.sc@honeywell.com](mailto:info.sc@honeywell.com)**

## Honeywell Sensing and Internet of Things

9680 Old Bailes Road  
Fort Mill, SC 29707  
[honeywell.com](http://honeywell.com)

002306-8-EN IL50 GLO  
August 2017  
© 2017 Honeywell International Inc. All rights reserved.

## **WARNING** **PERSONAL INJURY**

DO NOT USE these products as safety or emergency stop devices or in any other application where failure of the product could result in personal injury.

**Failure to comply with these instructions could result in death or serious injury.**

## **WARNING** **MISUSE OF DOCUMENTATION**

- The information presented in this product sheet is for reference only. Do not use this document as a product installation guide.
- Complete installation, operation, and maintenance information is provided in the instructions supplied with each product.

**Failure to comply with these instructions could result in death or serious injury.**

### Warranty/Remedy

Honeywell warrants goods of its manufacture as being free of defective materials and faulty workmanship during the applicable warranty period. Honeywell's standard product warranty applies unless agreed to otherwise by Honeywell in writing; please refer to your order acknowledgement or consult your local sales office for specific warranty details. If warranted goods are returned to Honeywell during the period of coverage, Honeywell will repair or replace, at its option, without charge those items that Honeywell, in its sole discretion, finds defective. **The foregoing is buyer's sole remedy and is in lieu of all other warranties, expressed or implied, including those of merchantability and fitness for a particular purpose. In no event shall Honeywell be liable for consequential, special, or indirect damages.**

While Honeywell may provide application assistance personally, through our literature and the Honeywell web site, it is buyer's sole responsibility to determine the suitability of the product in the application.

Specifications may change without notice. The information we supply is believed to be accurate and reliable as of this writing. However, Honeywell assumes no responsibility for its use.

# Honeywell